

RPI FEATURING REGAL VIENNA HUSSMANN®

2nd Edition

CONCEPTS ... TO REALITY!

GRAB & GO

SELF-SELECT

AIR SCREENS

© 2014 RPI INDUSTRIES, INC.

220 ROUTE 70 • MEDFORD NJ, 08055 • 609-714-2330 (PHONE) • 609-714-2331 (FAX)

CONCEPTS . . . TO REALITY!

Got a Product you'd like to show off to its Greatest Advantage?

The RPI Air Screen product line features refrigerated display cases that are simply the best solutions possible for showcasing a variety of different products. Manufactured to standard sizes, and available with an unlimited selection of attractive finishes, RPI's Air Screens allow for customization based upon your exact specifications to best enhance the display of your product line!



Our Goal is Simple!

To offer you superior value for a standard refrigerated display case! A One-Of-A-Kind design, or anything in between!

Our long standing proven ability to successfully combine refrigeration display with options ranging from custom millwork, to stainless steel fabrication, is your assurance that we can provide you the highest product consistency and continuity for your project regardless of its size!

There is no obstacle we can't handle!

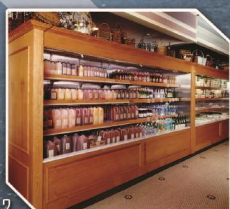

RPI INDUSTRIES, INC.

RPI REGAL PRODUCTS



Conforms to UL Standard 471,
and NSF Standard 7, Certified
To CSA Standard C22.2 No.120

TABLE OF CONTENTS

<i>P.06 Bandit Series - SCRFC</i>	<i>P.44-45 RPI Turbo Chill - Olympus SCAS-II-TC</i>
<i>P.07 Bandit Series - SCRFC-II</i>	<i>P.46-49 Customized Air Screens</i>
<i>P.08 Bandit Series - SCRFC-III</i>	<i>P.50-51 Manhattan Series - SCRFC MS</i>
<i>P.09 Bandit Series - Tray Slides</i>	<i>P.52-54 Stratus Self-Select Series -</i> <i>SCRFC-SSI, SCRFC-SSII, SCRFC-SSIII</i>
<i>P.10-11 Bandit Series - Advantages</i>	<i>P.55 Express Self-Select Monaco Series -</i> <i>SCXSSC</i>
<i>P.12-13 Bandit Series - Finishes</i>	<i>P.56-57 Continental Bakery Series -</i> <i>SCCB-CR, SCCB-CS, SCCB-CD</i>
<i>P.14 Bravo Series - SCRFC</i>	<i>P.57 Express Bakery Open Air Series - SCXSSB</i>
<i>P.15 Bravo Series - SCRFC UD + Middle Shelf Display</i>	<i>P.58-59 Continental Bakery Series - SCCB-OU</i>
<i>P.16 Olympus Series - SCAS / SCAS-II</i>	
<i>P.17 Olympus Series - Tray Slides</i>	
<i>P.18-19 Olympus Series - Advantages</i>	
<i>P.20-23 Olympus Series - Options</i>	
<i>P.24-25 Olympus Series - Decorative Paneling</i>	
<i>P.26-28 Olympus Series - Remote Refrigeration</i>	
<i>P.29 Olympus Series - Rear Trim Kit SCAS-II-CL-RR</i>	
<i>P.30-31 RPI Glycold</i>	
<i>P.32-35 RPI Green Screen</i>	
<i>P.36 Olympus Series - SCAS-III + SCAS-III Mini</i>	
<i>P.37-39 Olympus Series - SCAS-III Options</i>	
<i>P.40-41 Olympus Series - SCAS-III MC Milk Case</i>	
<i>P.42 Olympus Series - SCAS-DI / SCAS-DII</i>	
<i>P.43 Olympus Series - SCASH-I' / SCASH-II'</i>	

*** CONTACT FACTORY FOR SPECIFIC APPROVALS ***



RPI VIENNA PRODUCTS



Conforms to UL Standard 471,
and NSF Standard 7, Certified
to CSA Standard C22.2 No. 120

TABLE OF CONTENTS

P.60-63 Vienna Series Air Pans - Advantages	P.108-111 Vienna Series Island Display - VI-IS
P.64-65 Vienna Series Air Pans - VIAP / VIAP AT	
P.66 Vienna Series Air Pans - Slant	P.112-113 Vienna Series Cold Combo - VICC
P.67 Vienna Series Air Pans - Slant Extra Deep	
P.68-69 Vienna Series Air Pans - Slanted Displays Advantage	
P.70-71 Vienna Series Air Pans Curved - VIAP-CV / VIAP-CV AT	
P.72-73 Vienna Series Air Pans - Tilted Displays	
P.74-75 Vienna Series Air Pans - Sloped Displays	
P.76-84 Vienna Series Air Pans - Customized Advantage	
P.85-89 Vienna Series Lob Air Pans - VIAP-LOB / VIAP-LOB II	
P.90-92 Vienna Series Air Screens - Advantages / Installations	
P.93 Vienna Series Air Screens with Insulated Glass - VIAS INS	
P.94-95 Vienna Series Sliding Doors - VICD SD	
P.96-97 Vienna Series Flip-Up Doors - VICD FD	
P.98-103 Vienna Series Air Screens - Advantages	
P.104-105 Vienna Series Hot Display - VIHD CO*	
P.106-107 Vienna Series Counter Top Grab & Go - VIAS CT	

* CONTACT FACTORY FOR SPECIFIC APPROVALS



RPI HUSSMANN PRODUCTS



TABLE OF CONTENTS

<i>P.114-115 RPI & Hussmann Integrated</i>	<i>P.147 Excel Series - D5X-ULEP / D6NX-LEP</i>
<i>P.116-121 Specialty RGD / RGDC Series</i>	<i>P.148 Excel Series - D5X-LRE</i>
<i>P.122-123 Entyce Series - Sizes / Advantage</i>	<i>P.149 Excel Series - D5XRRJ</i>
<i>P.124-125 Specialty Isla Series - IMR</i>	<i>P.150 Excel Series - D6X-ULEP / P4X-E</i>
<i>P.126-127 Specialty Isla Series Modules</i>	<i>P.151 Specialty Series - FMSS</i>
<i>P.128-129 Specialty Isla Series Hot - IM-H</i>	<i>P.152 Specialty Series - RH1</i>
<i>P.130-131 Specialty Isla Series Advantages</i>	<i>P.153 Specialty Series - R12</i>
<i>P.132 Specialty Q Series - Q1-SS</i>	<i>P.154 Specialty Series - R13</i>
<i>P.133 Specialty Q Series - Q3-SS</i>	<i>P.155 Specialty Series - R14</i>
<i>P.134 Specialty Q Series - Q3-SP</i>	<i>P.156 Specialty Series - CR3D</i>
<i>P.135-136 Specialty Q Series - Advantages</i>	<i>P.157 Specialty Series - R3D</i>
<i>P.137 Impact Elite Series - E2 / E3</i>	<i>P.158 Specialty Series - CR3HV-NB</i>
<i>P.138 Impact Elite Series - E2S / E2SP</i>	<i>P.159 Specialty Series - CR3HV-WB</i>
<i>P.139 Impact Elite Series - E4 / E5</i>	<i>P.160 Specialty Series - R3HV-WD</i>
<i>P.140 Impact Elite Series - E3-XC / E3S</i>	<i>P.161 Specialty Series - R3HV-WD</i>
<i>P.141 Excel Series - B3XC-LEP / LGEP</i>	<i>P.162 Specialty Series - SHM</i>
<i>P.142 Excel Series - B4X-E / C2X-X</i>	<i>P.163 Specialty Series - GSVM</i>
<i>P.143 Excel Series - C6X / C6X-LRE</i>	<i>P.164 Specialty Series - MD</i>
<i>P.144 Excel Series - CR3D</i>	<i>P.165 Self Select Series - DDSS-4MC</i>
<i>P.145 Excel Series - CR3FO</i>	<i>P.166 Self Select Series - ISMGG / ISFGG</i>
<i>P.146 Excel Series - CR3P</i>	<i>P.167 Product Check List</i>

* CONTACT FACTORY FOR SPECIFIC APPROVALS





BANDIT AIR SCREEN

78 INCH TALL UNIT



The Bandit Air Screen SCRFC Series is a grab and go style refrigerator. The self-contained refrigeration system includes digital controls allowing unit to engage in minimal defrost cycles. Front mounted red indicator light alerts operator if condensing unit requires cleaning. Unique baffled compressor housing for front air intake, top rear air discharge reducing noise levels, plus zero clearance from wall installation. Unit comes standard with 4 adjustable extra deep shelves and top canopy light. Optional lights underneath shelving available in T5 fluorescent or energy efficient LED lighting.

MODEL	L	D	H	MODEL	L	D	H
SCRFC3600R	36"	32.3/8"	60"	SCRFC3678R	36"	32.3/8"	78"
SCRFC4800R	48"	32.3/8"	60"	SCRFC4878R	48"	32.3/8"	78"
SCRFC6000R	60"	32.3/8"	60"	SCRFC6078R	60"	32.3/8"	78"
SCRFC7200R	72"	32.3/8"	60"	SCRFC7278R	72"	32.3/8"	78"

SPECIAL FEATURES

60 INCH TALL UNIT



OPTIONAL LOCKING SECURITY PANELS

OVER 100 CHOICES OF STANDARD LAMINATES AVAILABLE!



SPACE BANDIT II AIR SCREEN

The Space Bandit Air Screen SCRFC-II Series is a grab and go style refrigerator with contemporary style insulated glass end panels designed to include an optional roll down locking night cover. The self-contained refrigeration system includes digital controls allowing unit to engage in minimal defrost cycles. Front mounted red indicator light alerts operator if condensing unit requires cleaning. Unique baffled compressor housing for front air intake, top rear air discharge reducing noise levels, plus zero clearance from wall installation. Standard extra deep shelving offers 20% additional merchandising space. Unit comes standard with top canopy light. Optional lights underneath shelving are available in T5 fluorescent or optional energy efficient LED lighting.



MODEL	L	D	H
SCRFC4878R-B	48"	35.34"	78"
SCRFC6078R-B	60"	35.34"	78"
SCRFC7278R-B	72"	35.34"	78"

OVER 100 CHOICES OF STANDARD LAMINATES AVAILABLE!

SPECIAL FEATURES



OPTIONAL ROLL DOWN LOCKING NIGHT COVER 7.



BANDIT III AIR SCREEN

OUR MOST POPULAR MODEL!

The Bandit III Air-Screen SCRFC-III Series is a grab and go style refrigerator. The self-contained refrigeration system includes digital controls allowing the unit to engage in minimal defrost cycles. Front mounted red indicator light alerts the operator if condensing unit requires cleaning. Unique baffled compressor housing for front air intake, top rear air discharge reducing noise levels plus zero clearance from wall installation. Unit also features an optional roll-down locking night cover. Unit comes standard with 4 adjustable extra deep shelves and top canopy light. Optional lights underneath shelving available in T5 fluorescent or energy efficient LED lighting.

MODEL	L	D	H	MODEL	L	D	H
SCRFC160R-W	36"	22.34"	60"	SCRFC317R-W	36"	22.34"	78"
SCRFC460R-W	48"	22.34"	60"	SCRFC417R-W	48"	22.34"	78"
SCRFC560R-W	60"	22.34"	60"	SCRFC617R-W	60"	22.34"	78"
SCRFC720R-W	72"	22.34"	60"	SCRFC717R-W	72"	22.34"	78"

**NOW AVAILABLE WITH OPTIONAL ROLL DOWN LOCKING NIGHT COVER
OVER 100 CHOICES OF STANDARD LAMINATES AVAILABLE!**

SPECIAL FEATURES



60 INCH TALL UNIT



OPTIONAL ROLL DOWN LOCKING NIGHT COVER

UNITS SHOWN WITH OPTIONAL STAINLESS STEEL EXTERIOR FINISH

78 INCH TALL UNIT



BANDIT SERIES OPTIONS

TRAY SLIDES

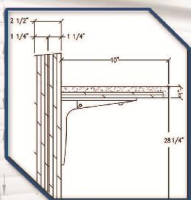
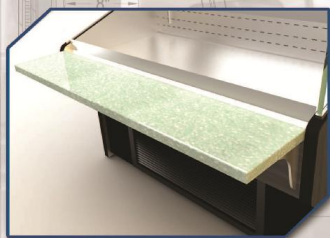

CORIAN® FINISH

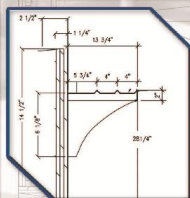

STAINLESS STEEL FINISH

TRAY SLIDES AVAILABLE ON CUSTOMIZED BANDIT AIR SCREENS ONLY

CONSULT FACTORY FOR ADDITIONAL INFORMATION 9



ADVANTAGE . . .

BANDIT AIRSCREEN



**OPTIONAL ENERGY EFFICIENT LED LIGHTS
LOCATED UNDER EACH SHELF**



**ADJUSTABLE STAINLESS STEEL EXTRA DEEP
SHELVES FOR MAXIMUM CAPACITY**



**REMOVABLE HEMMED STAINLESS
STEEL DECK PAN TO CONTAIN SPILLS**



**DIGITAL DEFROST ON DEMAND
INCLUDING COIL WARNING LIGHT**

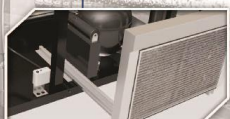

**PULL-OUT COMPRESSOR FOR EASY
CLEANING**





ADVANTAGE . . .

BANDIT SERIES



ZERO CLEARANCE FROM WALL

SPACE SAVER!

AIR IS EXHAUSTED UP AND OUT OF THE TOP REAR OF THE REFRIGERATOR.

REQUIRES 12" MINIMUM CLEARANCE FROM CEILING

AIRFLOW



TOP REAR AIR DISCHARGE

FRONT AIR INTAKE



BANDIT SERIES OPTIONS

OVER 100 CHOICES OF STANDARD GRADE LAMINATE OPTIONS AVAILABLE*



BELOW IS A BRIEF SAMPLING OF WILSONART® COLOR SELECTION

LAMINATE COLORS VARY FROM PRINTED REPRODUCTION
VIEW ACTUAL SAMPLE FOR COLOR

* STANDARD LAMINATE OPTIONS AVAILABLE FOR ALL RPI AIR SCREENS

PLEASE CONSULT FACTORY FOR ADDITIONAL EXTERIOR FINISHES

RPI

BANDIT SERIES OPTIONS

WOOD VENEERS

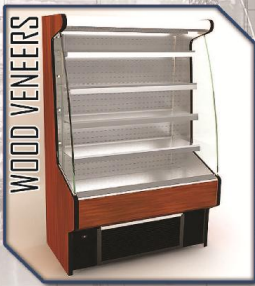

EBONY

CHERRY

MARLE

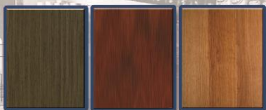

WENGE

WALNUT

OAK

STAIN COLOR CAN VARY
VIEW ACTUAL WOOD FINISH SAMPLE FOR COLOR

**VARIETY OF PREMIUM
EXTERIOR FINISHES AVAILABLE**

STAINLESS STEEL



SPECIAL LAMINATES

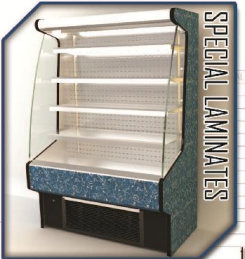



BRAVO AIR SCREEN



The Bravo Air Screen SCRFC Series is a refrigerated self-service display case with front and optional rear air grills, brushed aluminum interior ends and a choice of standard grade plastic laminate exterior. The self-contained refrigeration system includes digital controls allowing unit to engage in minimal defrost cycles. Front mounted red indicator light alerts the operator if condensing unit requires cleaning. Optional stainless steel exterior available upon request. Unique design allows zero clearance from wall.

MODEL	L	D	H
SCRFC648R	36"	32.38"	45 1/8"
SCRFC648R	48"	32.38"	45 1/8"
SCRFC648R	60"	32.38"	45 1/8"
SCRFC7248R	72"	32.38"	45 1/8"

OVER 100 CHOICES OF STANDARD LAMINATES AVAILABLE!

BRAVO SERIES SPECIAL FEATURES



OPTIONAL STEP PLATE



OPTIONAL ROLL DOWN LOCKING NIGHT COVER



BRAVO AIR SCREEN WITH MIDDLE SHELF

The Bravo Air Screen with Middle Shelf SCRFC-MIDD Series is a refrigerated self-service display case with front and optional rear air grills, Interior 10 Inch Middle Shelf, brushed aluminum interior ends and a choice of standard grade plastic laminate exterior. The self-contained refrigeration system includes digital controls allowing unit to engage in minimal defrost cycles. Front mounted red indicator light alerts the operator if condensing unit requires cleaning. Optional stainless steel exterior available upon request. Unique design allows zero clearance from wall.

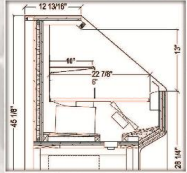

MODEL	L	D	H
SCRFC3648R-MIDD	36"	32.33"	45.18"
SCRFC4848R-MIDD	48"	32.33"	45.18"
SCRFC6048R-MIDD	60"	32.33"	45.18"
SCRFC7248R-MIDD	72"	32.33"	45.18"



OVER 100 CHOICES OF STANDARD LAMINATES AVAILABLE!

BRAVO AIR SCREEN WITH UPPER DISPLAY

The Bravo Air Screen with Upper Display SCRFC UD Series has two sections. An upper ambient display with a satin finish metal frame and glass front, sides and top, hinged glass rear doors, (2) adjustable glass shelves and a fluorescent canopy light. The lower section is a refrigerated self-service display with front and rear air grills, brushed aluminum interior ends and a choice of standard grade plastic laminate exterior. Optional stainless steel exterior available upon request.

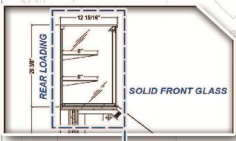

MODEL	L	D	H
SCRFC3648R UD	36"	32.33"	65.38"





OLYMPUS I AIR SCREEN



The Olympus Air Screen SCAS Series is a grab and go style refrigerator. The self-contained refrigeration system includes digital controls allowing unit to engage in minimal defrost cycles. Front mounted red indicator light alerts operator if condensing unit requires cleaning. Unique baffled compressor housing for front air intake, top rear air discharge reducing noise levels, plus zero clearance from wall installation. Unit comes standard with 4 adjustable extra deep shelves and is available with T5 fluorescent lights or optional energy efficient LED lighting underneath shelving.

MODEL	L	D	H
SCAS36R-SC	36"	32"	78"
SCAS48R-SC	48"	32"	78"
SCAS60R-SC	60"	32"	78"
SCAS72R-SC	72"	32"	78"

OLYMPUS II AIR SCREEN

NOW AVAILABLE WITH OPTIONAL STAINLESS STEEL EXTERIOR FINISH

The Olympus II Air Screen SCAS-II Series is a grab and go style refrigerator. The self-contained refrigeration system includes digital controls allowing unit to engage in minimal defrost cycles. Front mounted red indicator light alerts operator if condensing unit requires cleaning. Unique baffled compressor housing for front air intake, top rear air discharge reducing noise levels, plus zero clearance from wall installation. Unit comes standard with 4 adjustable extra deep shelves and is available with T5 fluorescent lights or optional energy efficient LED lighting underneath shelving.



MODEL	L	D	H
SCAS36R-II-SC	36"	32"	78"
SCAS48R-II-SC	48"	32"	78"
SCAS60R-II-SC	60"	32"	78"
SCAS72R-II-SC	72"	32"	78"

OVER 100 CHOICES OF STANDARD LAMINATES AVAILABLE!

CONSULT FACTORY FOR ADDITIONAL INFORMATION



OLYMPUS SERIES OPTIONS

TRAY SLIDES

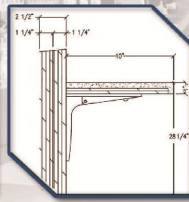

CORIAN® FINISH

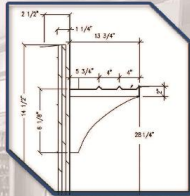

STAINLESS STEEL FINISH

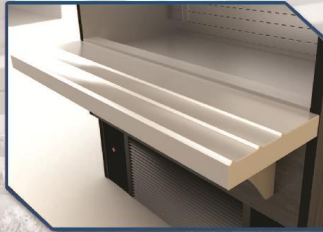

TRAY SLIDES AVAILABLE ON CUSTOMIZED OLYMPUS AIR SCREENS ONLY

CONSULT FACTORY FOR ADDITIONAL INFORMATION 17.



ADVANTAGE . . .

OLYMPUS SERIES



**OPTIONAL ENERGY EFFICIENT LED LIGHTS
LOCATED UNDER EACH SHELF**



STAINLESS HEMMED DECK PAN

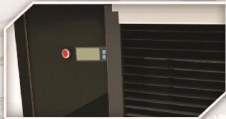

**DIGITAL TEMPERATURE
CONTROLS BEHIND PANEL**



**PULL-OUT COMPRESSOR FOR
EASY CLEANING**



**EASY LIFT-OFF LOUVERED
AIR GRILL**



SPACE SAVER!

AIR IS EXHAUSTED UP AND OUT OF THE TOP REAR OF THE REFRIGERATOR

REQUIRES 12" MINIMUM CLEARANCE FROM CEILING

2" AIR SPACE CHIMNEY ON REAR OF UNIT

AIRFLOW





OLYMPUS SERIES OPTIONS

* OPTIONAL GRAPHICS AVAILABLE ON NIGHT SHADES



ECONO FROST NIGHT SHADE



MIRROR STAINLESS EXTERIOR



ROLL DOWN LOCKING NIGHT COVER



REAR DOORS WITH FINISHED BACK AND BLACK AIR GRILL

NOTE: OLYMPUS I, II, & III UNITS ARE 29 3/4" DEEP WHEN INSTALLED WITH REAR ACCESS DOORS



OLYMPUS SERIES OPTIONS



OPTIONAL CASTERS

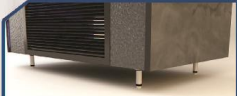
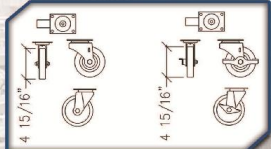

BULLET FEET / OPTIONAL LEGS

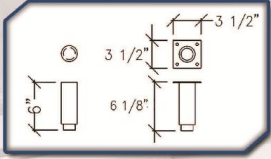

CASTERS / LEGS WITH STEM POST CASTERS ARE 6" TO THE PLATE

BASE PANEL COVERINGS



STAINLESS STEEL



LAMINATE

BASE PANELS AVAILABLE ON REMOTE, WATER-COOLED, OR GLYCOL UNITS ONLY



OLYMPUS SERIES OPTIONS

GRAVITY-FEED SHELVING

GRAVITY FEED SHELVING AVAILABLE IN WHITE, BLACK OR CHROME FINISH

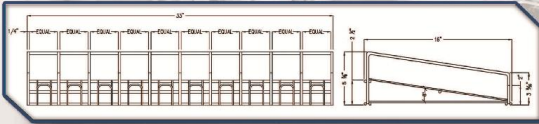

GRAVITY FEED SHELVING AVAILABLE FOR USE WITH CANS ONLY



EXTENDED SHELVING



OLYMPUS SERIES OPTIONS

TIE-IN STRIPS

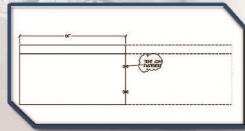
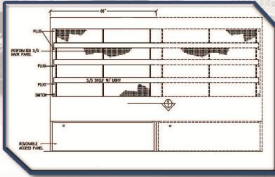

OFFERING A "SEAMLESS FLOW" AND "CONTINUAL LOOK" TO THE AIR SCREENS

SLAT WALL DISPLAY



CONSULT FACTORY FOR ADDITIONAL INFORMATION 



OLYMPUS SERIES - DECORATIVE PANELING

REMOTE REFRIGERATED UNITS ONLY

STYLE 1



STAINLESS STEEL FLAT

STYLE 2



RECESSED QUIRK LINE WITH
STAINLESS STEEL TRIM



STYLE 3



WOOD VENEERS

OLYMPUS I & II REMOTE CASES OFFER FRONT DECORATIVE PANELS ON REMOVABLE CLEATS FOR EASY ACCESS TO DRAIN LINES AND REFRIGERATION CONNECTIONS



OLYMPUS SERIES - DECORATIVE PANELING



**WOOD VENEER EXTERIOR OFFERED
WITH RAISED TRIM AND TOP CROWN MOLDING!**



**PERSONALIZE THE FRONT WITH COMPANY LOGO!
(CUSTOMER TO SUPPLY ARTWORK)**

CONSULT FACTORY FOR ADDITIONAL INFORMATION 25

RPI

OLYMPUS SERIES OPTIONS

REMOTE REFRIGERATION

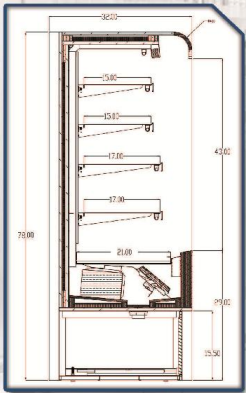

**OLYMPUS - RR
STANDARD**



26. CONSULT FACTORY FOR ADDITIONAL INFORMATION



OLYMPUS SERIES OPTIONS

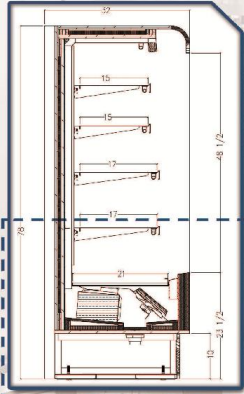

**OLYMPUS - RR XL
EXTENDED**
OFFERS LARGER
MERCHANDISING CAPACITY



REMOTE REFRIGERATION

**LOWER DECK HEIGHT FOR
EXTRA SHELVING CAPACITY**

CONSULT FACTORY FOR ADDITIONAL INFORMATION 27.

OPTION 1

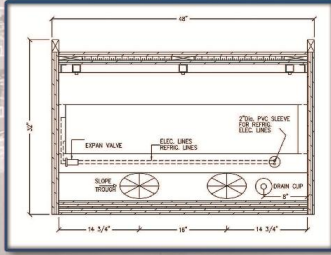

TWO OPTIONS AVAILABLE FOR REMOTE REFRIGERATION:

- 1. REFRIGERATED LINES AND DRAIN CUP LEADING TO FLOOR DRAIN
- 2. REFRIGERATED LINES AND DRAIN CUP LEADING TO EVAP PAN

(CASE WITH EVAPORATOR PAN WILL REQUIRE FROST VENTILATION KIT)

EVAP PAN INSTALLATION REQUIRES AXIAL FAN FOR DISPATCHING OF MOISTURE

OPTION 2

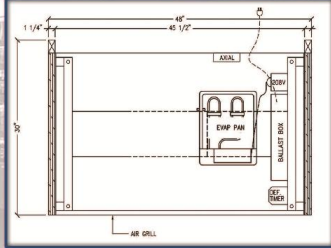

28. LOUVERED GRILL REQUIRED WHEN USING EVAP PAN

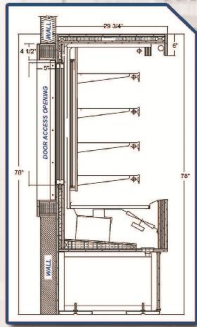

REAR TRIM KIT FOR WALK-IN COOLERS OR "THROUGH THE WALL" INSTALLATIONS

REAR TRIM KIT IS AN OPTIONAL FEATURE FOR OLYMPUS AIRSCREENS, ALLOWING FOR "THROUGH THE WALL" INSTALLATION, WITH REAR ACCESS AVAILABILITY.

- **AVAILABLE AS A REMOTE UNIT ONLY**
- **FLOOR DRAIN REQUIRED**

SCAS-II-CL-RR

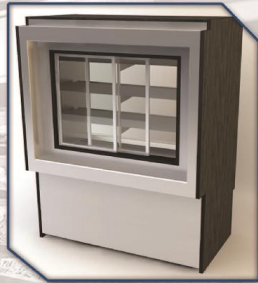

THROUGH THE WALL INSTALLATION (REAR DOORS OPTION NOT SHOWN)

CONSULT FACTORY FOR ADDITIONAL INFORMATION 29.

RPI GLYCOLD

- Totally Food-Safe Glycol System
- Reduces Energy Consumption
- Enhances Performance
- Environmentally-Friendly Refrigeration
- Digitally Controlled Solenoid Valve
- Propylene Glycol Refrigerant



Regal Air Screen Refrigerators are available with "Glycold" option for remote application!



MODEL	L	D	H	SEC. REFRIG.
SCAS36R-RR-GL	36"	32"	78"	GLYCOL
SCAS48R-RR-GL	48"	32"	78"	GLYCOL
SCAS60R-RR-GL	60"	32"	78"	GLYCOL
SCAS72R-RR-GL	72"	32"	78"	GLYCOL

MODEL	L	D	H	SEC. REFRIG.
SCAS36R-II-RR-GL	36"	32"	78"	GLYCOL
SCAS48R-II-RR-GL	48"	32"	78"	GLYCOL
SCAS60R-II-RR-GL	60"	32"	78"	GLYCOL
SCAS72R-II-RR-GL	72"	32"	78"	GLYCOL



30.

PLEASE CONSULT OUR FACTORY FOR ALL STYLES AND MODEL NUMBERS AVAILABLE WITH THE "GL OPTION"

RPI GLYCOLD

MODEL	L	D	H	SEC REFRIG.
SCRFC3660 / 3678R-RR-GL	36"	32 3/8"	60 7/8"	GLYCOL
SCRFC4860 / 4878R-RR-GL	48"	32 3/8"	60 7/8"	GLYCOL
SCRFC6060 / 6078R-RR-GL	60"	32 3/8"	60 7/8"	GLYCOL
SCRFC7260 / 7278R-RR-GL	72"	32 3/8"	60 7/8"	GLYCOL



MODEL	L	D	H	SEC REFRIG.
SCRFC4878R-II-RR-GL	48"	35 3/4"	78"	GLYCOL
SCRFC6078R-II-RR-GL	60"	35 3/4"	78"	GLYCOL
SCRFC7278R-II-RR-GL	72"	35 3/4"	78"	GLYCOL



MODEL	L	D	H	SEC REFRIG.
SCRFC3660 / 3678R-III-RR-GL	36"	32 3/8"	60 7/8"	GLYCOL
SCRFC4860 / 4878R-III-RR-GL	48"	32 3/8"	60 7/8"	GLYCOL
SCRFC6060 / 6078R-III-RR-GL	60"	32 3/8"	60 7/8"	GLYCOL
SCRFC7260 / 7278R-III-RR-GL	72"	32 3/8"	60 7/8"	GLYCOL



MODEL	L	D	H	SEC REFRIG.
SCRFC3648R-RR-GL	36"	32 3/8"	45 1/8"	GLYCOL
SCRFC4848R-RR-GL	48"	32 3/8"	45 1/8"	GLYCOL
SCRFC6048R-RR-GL	60"	32 3/8"	45 1/8"	GLYCOL
SCRFC7248R-RR-GL	72"	32 3/8"	45 1/8"	GLYCOL



PLEASE CONSULT OUR FACTORY FOR ALL STYLES AND MODEL NUMBERS AVAILABLE WITH THE "GL OPTION"

LED LIGHTING

PART OF OUR GREEN SCREEN INITIATIVE, LED LIGHTING IS OFFERED AS A LOW AMPERAGE, MERCURY FREE, LONG-LASTING ILLUMINATION SOLUTION



GOING GREEN

We are comitted to this initiative by offering **OPTIONAL** construction for Olympus, Bandit and Bravo Air Screens with the following features:

- High efficient CFC Free Refrigerant
- LED Lighting: low amperage, mercury free, long lasting illumination
- ECM programmable High Efficiency evaporator fan motor and blade for low power consumption
- Electronic digital control and defrost termination minimizes times for defrost cycle. **FASTER RECOVERY, LESS ENERGY**
- Heavy Duty woven aluminum econofrost night shades reduce energy consumption for off peak hours
- Frames are constructed of recycled aluminum
- Stainless steel uses high percentage of recycled stainless and carbon steel
- Laminates are Wilsonart®
 - MR4 Recycled Content
 - MR5 Regional Materials
 - MR7 Certified Wood
 - FSC Certified - HD® and Aeon™ finishes
- Cabinet construction FSC (Forest Stewardship Council) certified wood products (When Specified)
- Pure Bond formaldehyde free adhesives and melamine
- 100% Recycled laminate finishes
- Standard Laminates *LEED® approved



OLYMPUS G



MODEL	L	D	H
SCAS36R-G	36"	32"	78"
SCAS48R-G	48"	32"	78"
SCAS60R-G	60"	32"	78"
SCAS72R-G	72"	32"	78"

MODEL	L	D	H
SCAS36R-II-G	36"	32"	78"
SCAS48R-II-G	48"	32"	78"
SCAS60R-II-G	60"	32"	78"
SCAS72R-II-G	72"	32"	78"



OLYMPUS II G

CONSULT FACTORY FOR ADDITIONAL INFORMATION 33

RPI GREEN SCREEN™

MODEL	L	D	H
SCRFC3660 / 3678R-G	36"	32 3/8"	60/78"
SCRFC4860 / 4878R-G	48"	32 3/8"	60/78"
SCRFC6060 / 6078R-G	60"	32 3/8"	60/78"
SCRFC7260 / 7278R-G	72"	32 3/8"	60/78"



MODEL	L	D	H
SCRFC4878R-II-G	48"	35 3/4"	78"
SCRFC6078R-II-G	60"	35 3/4"	78"
SCRFC7278R-II-G	72"	35 3/4"	78"

34. CONSULT FACTORY FOR ADDITIONAL INFORMATION



BANDIT III G

MODEL	L	D	H
SCRFC3660 / 3678R-III-G	36"	32 3/8"	60/78"
SCRFC4860 / 4878R-III-G	48"	32 3/8"	60/78"
SCRFC6060 / 6078R-III-G	60"	32 3/8"	60/78"
SCRFC7260 / 7278R-III-G	72"	32 3/8"	60/78"



BRAVO G

MODEL	L	D	H
SCRFC3648R.G	36"	32 3/8"	45 1/8"
SCRFC4848R.G	48"	32 3/8"	45 1/8"
SCRFC6048R.G	60"	32 3/8"	45 1/8"
SCRFC7248R.G	72"	32 3/8"	45 1/8"

CONSULT FACTORY FOR ADDITIONAL INFORMATION 35



OLYMPUS III AIR SCREEN

The Olympus III Air Screen SCAS-III Series is a top-mount, grab and go style refrigerator allowing a lower front deck, which offers additional shelf space. Top header is available with optional illustrated panel section, allowing for unique merchandising signature. The self-contained refrigeration system includes digital controls allowing the unit to engage in minimal defrost cycles. Unit comes standard with exterior laminate finish, 3 adjustable extra deep shelves, T5 fluorescent lights or optional energy efficient LED lighting underneath shelving. Unit also comes standard with laminate top panel and lighted top panel is available as an option.

MODEL	L	D	H
SCAS36R-W	36"	32"	91"
SCAS48R-W	48"	32"	91"
SCAS60R-W	60"	32"	91"
SCAS72R-W	72"	32"	91"



NOTE: 4th Adjustable extra deep shelf available as an option



OLYMPUS III AIR SCREEN MINI

The Olympus III Air Screen SCAS-III MINI Series is a top-mount, grab and go style refrigerator allowing a lower front deck, which offers additional shelf space, and a lower height for doorway clearance. Top header is standard with optional illustrated panel section, allowing for unique merchandising signature. The self-contained refrigeration system includes digital controls allowing the unit to engage in minimal defrost cycles. Unit comes standard with exterior laminate finish, 3 adjustable extra deep shelves, T5 fluorescent lights or optional energy efficient LED lighting underneath shelving. Unit also comes standard with laminate top panel and lighted top panel is available as an option.

MODEL	L	D	H
SCAS36R-III MINI	36"	32"	83"
SCAS48R-III MINI	48"	32"	83"
SCAS60R-III MINI	60"	32"	83"
SCAS72R-III MINI	72"	32"	83"



36" * 36" UNITS REQUIRE 2 CIRCUITS IF EVAPORATOR PAN IS NEEDED

RPI

OLYMPUS III SERIES OPTIONS

OPTIONAL GLASS SIDE PANELS

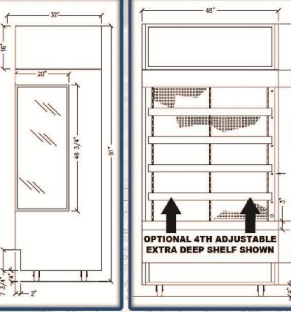

**OPTIONAL 4TH ADJUSTABLE
EXTRA DEEP SHELF SHOWN**



FRONT MERCHANDISING RACKS

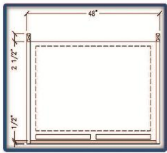
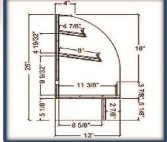

CUSTOM INSTALLATION OPTIONS AND FEATURES AVAILABLE

PLEASE CONSULT FACTORY FOR ADDITIONAL INFORMATION 37



EXTENDED ILLUSTRATION PANEL

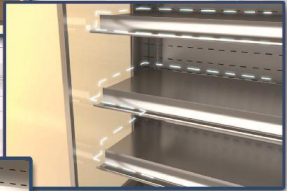

EXTENDED SHELVING



SLAT WALL DISPLAY

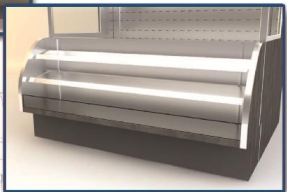

CHIP DISPLAY EXTENSION
AVAILABLE WITH
LOCKABLE PANELS (OPTIONAL)



ADVANTAGE . . .

OLYMPUS III AIR SCREEN



ILLUMINATED ILLUSTRATION PANEL



ZERO CLEARANCE FROM WALL
18" TO 24" TOP CLEARANCE REQUIRED



OPTIONAL ENERGY EFFICIENT LED LIGHTS
LOCATED UNDER EACH SHELF



STAINLESS HEMMED DECK PAN

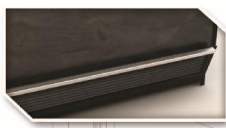

EASY LIFT-OFF LOUVERED
AIR GRILL





OLYMPUS III MILK CASE

The Olympus Milk Case SCAS-III MC Series is a grab and go style air screen refrigerator with slide-in accessibility behind tray rails or die walls. Unit features large heated hinged glass doors in rear for easy placement of milk crates onto the heavy duty 9/8 deck pan. Top mount compressor enables recessed deck to accommodate milk crates. Unit comes standard with exterior laminate finish, and is available with TS fluorescent lights or optional energy efficient LED lighting underneath shelving.

MODEL	L	D	H
SCAS36R-W MC*	36"	29 3/4"	91"
SCAS48R-W MC	48"	29 3/4"	91"
SCAS60R-W MC	60"	29 3/4"	91"
SCAS72R-W MC	72"	29 3/4"	91"

NOTE: 2 REAR ACCESS DOORS
AVAILABLE ON 5 AND 6 FOOT UNITS ONLY

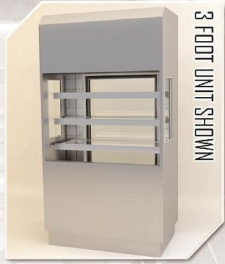

SPECIAL FEATURES

UNIT SHOWN WITH OPTIONAL
STAINLESS STEEL EXTERIOR FINISH



TOP MOUNT COMPRESSOR



**HEATED GLASS
REAR ACCESS DOORS**

40. * 36" UNITS REQUIRE 2 CIRCUITS IF EVAPORATOR PAN IS NEEDED

RPI ADVANTAGE ... OLYMPUS III MILK CASE



SCAS36R-III MC



SCAS48R-III MC



SCAS60R-III MC



RECESSED DECK TO ACCOMMODATE MILK CRATES

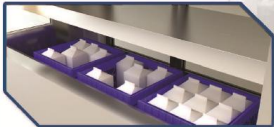

MILK CRATE DISPLAY



SCAS72R-III MC

OPTIONAL ROLL DOWN
LOCKING NIGHT COVER SHOWN

CONSULT FACTORY FOR ADDITIONAL INFORMATION 41



DROP-IN OLYMPUS I



The Olympus Drop-In Air Screen SCAS-DI-I Series is a grab and go style refrigerator. The self-contained refrigeration system includes digital controls. Unit comes standard with 2 adjustable shelves, with T5 fluorescent lighting or optional energy efficient LED lighting underneath shelving.

Unit is designed to drop or slide into a counter.

MODEL	L	D	H
SCAS36R-DI-I	36"	26"	68 1/2"
SCAS48R-DI-I	48"	26"	68 1/2"
SCAS60R-DI-I	60"	26"	68 1/2"
SCAS72R-DI-I	72"	26"	68 1/2"

NOTE: Verify that the in-field installation has sufficient height access to lift units into counter openings without upper soffit obstructions.

Units also require proper Louvered Grill Installation within cabinet base (Provided by others)

*34" high cabinets require 6" adjustable stainless steel legs
*36" high cabinets require 8" adjustable stainless steel legs



UNITS SHIPPED WITH LOOSE STAINLESS STEEL TRIM RING TO CLOSE OFF COUNTER CUT OUT

DROP-IN OLYMPUS II

The Olympus II Drop-In Air Screen SCAS-DI-II Series is a grab and go style refrigerator. The self-contained refrigeration system includes digital controls. Unit comes standard with 2 adjustable shelves, with T5 fluorescent lighting or optional energy efficient LED lighting underneath shelving.

Unit is designed to drop or slide into a counter.

MODEL	L	D	H
SCAS36R-DI-II	36"	25"	68 1/2"
SCAS48R-DI-II	48"	25"	68 1/2"
SCAS60R-DI-II	60"	25"	68 1/2"
SCAS72R-DI-II	72"	25"	68 1/2"

OPTIONAL STAINLESS STEEL EXTERIOR FINISH AVAILABLE





OLYMPUS WARMER I

The Olympus Warmer SCASH-I Series is a heated self-service display case with individually controlled warming shelves. Shelves can be heated up to 145°F. Available with a choice of standard grade plastic laminate exterior ends.

MODEL	L	D	H
SCAS489M	48"	32"	78"
SCAS609M	60"	32"	78"
SCAS729M	72"	32"	78"



INDIVIDUALLY CONTROLLED WARMING SHELVES



UNIT CONTROLS LOCATED BEHIND HINGED FOLD-DOWN LOUVERED GRILL

The Olympus II Warmer SCASH-II Series is a heated self-service display case with individually controlled warming shelves. Shelves can be heated up to 145°F. Like the SCASH-I, the SCASH-II is available with a choice of standard grade plastic laminate exterior ends.

MODEL	L	D	H
SCAS489MII	48"	32"	78"
SCAS609MII	60"	32"	78"
SCAS729MII	72"	32"	78"



OLYMPUS WARMER II



OPTIONAL STAINLESS STEEL EXTERIOR FINISH AVAILABLE 43



OLYMPUS II TURBO CHILL AIR SCREEN



The Olympus II Turbo Chill Air Screen SCAS-II TC Series is a unique design that will chill 75°F room temperature product to 40°F in two hours or less. Unit is available with standard grade plastic laminate exterior, and a choice of T5 fluorescent lights or optional energy efficient LED lighting underneath shelving.

Two sets of digital temperature controls operate the unit, one for normal mode and one for turbo chill mode. Both Sets of controls are located behind a removable top front panel.

MODEL	L	D	H
SCAS88R-II TC	60"	32"	78"

HOW DOES IT WORK?

Upon loading the cooler with room temperature product; press and hold the "Door Closed" Button to close the insulated security door, then momentarily press the "Turbo Start" Button.

OPTIONAL STAINLESS STEEL EXTERIOR FINISH AVAILABLE

SPECIAL FEATURES

STANDARD CONTROLS

FOR REGULAR GRAB AND GO MODE

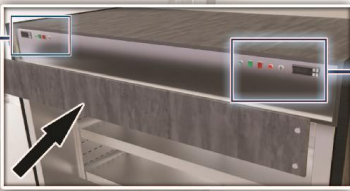

Removable Top Front Panel

TURBO CHILL CONTROLS



OLYMPUS II TURBO CHILL AIR SCREEN



**MOTORIZED ROLL DOWN LOCKING
SECURITY COVER**

**MULTI-DIRECTIONAL COOLING
SYSTEM**
PATENT PENDING



*COMBINATION OF OUR REFRIGERATION SYSTEM WITH ADDITIONAL TURBO FANS
ALLOWS THE PRECISE MULTI-DIRECTIONAL AIRFLOW NEEDED TO CHILL 75°F
ROOM TEMPERATURE PRODUCT TO 40°F IN TWO HOURS OR LESS*

ADVANTAGE - RPI TURBO CHILL

CONSULT FACTORY FOR ADDITIONAL INFORMATION 45

RPI

CUSTOMIZED AIR SCREENS



46. CONSULT FACTORY FOR ADDITIONAL INFORMATION



CUSTOMIZED AIR SCREENS

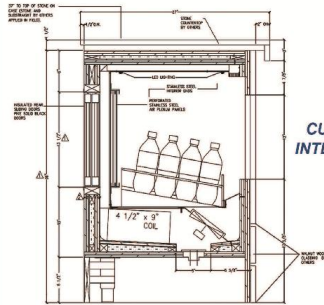
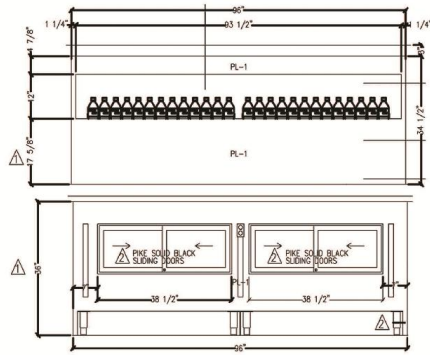

CUSTOMIZED COUNTER WITH INTEGRATED OPEN AIR SCREEN

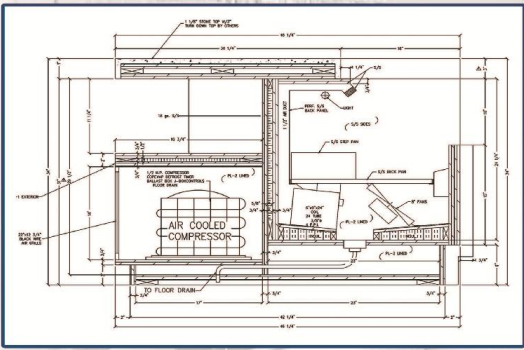

48. CONSULT FACTORY FOR ADDITIONAL INFORMATION

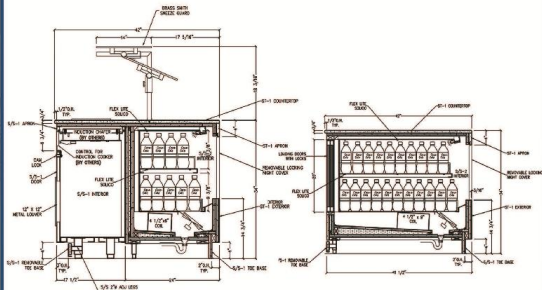

ADDITIONAL INSTALLATION OPTIONS AVAILABLE

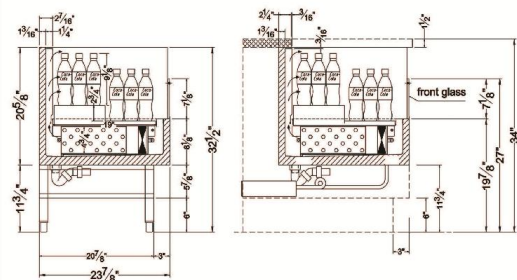

CONSULT FACTORY FOR ADDITIONAL INFORMATION 49



MANHATTAN AIR SCREEN

The Manhattan SCRFC MS Series is a three section display case consisting of a refrigerated self-service lower section, a refrigerated operator serve mid section and an operator serve non-refrigerated upper section. The lower section has a hemmed edge removable deck pan to contain spills. A glass shelf separates the mid and bottom sections for better visibility of product.

MODEL	L	D	H
SCRFC488 MS	48"	35 1/4"	65 1/4"

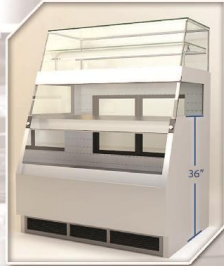

OVER 100 CHOICES OF STANDARD LAMINATES AVAILABLE!

SPECIAL FEATURES

TOP SECTION



**OPERATOR SERVE
NON-REFRIGERATED UPPER
SECTION**

MID SECTION

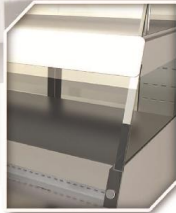

**OPERATOR SERVE
REFRIGERATED MID-SECTION**

BOTTOM SECTION



**SELF-SERVICE LOWER
SECTION**

50. OPTIONAL STAINLESS STEEL EXTERIOR FINISH AVAILABLE

RPI

MANHATTAN AIR SCREEN



VARIOUS INSTALLATIONS



CONSULT FACTORY FOR ADDITIONAL INFORMATION 51



STRATUS I AIR SCREEN

The Stratus Air Screen SCRFC-SSI Series is designed as a self-select grab and go refrigerator in the front with rear working area on the operator service side. Open storage and vertical glass protector guard with stainless steel posts are mounted to a stainless steel workboard surface, along with a removable zip lite cutting board. Available with a choice of standard grade plastic laminate exterior ends.



MODEL	L	D	H
SCRFC48R-SSI	48"	48"	54 5/8"
SCRFC60R-SSI	60"	48"	54 5/8"
SCRFC72R-SSI	72"	48"	54 5/8"

SPECIAL FEATURES

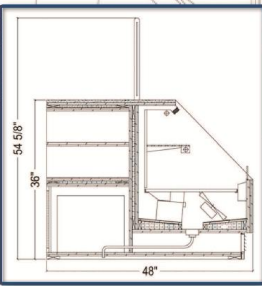

ADDITIONAL STORAGE CAPACITY LOCATED ON THE REAR OF THE UNIT

52. OPTIONAL STAINLESS STEEL EXTERIOR FINISH AVAILABLE



STRATUS II AIR SCREEN

The Stratus II Air Screen SCRFC-SSII Series is designed as a self-select grab and go refrigerator in the front and with rear drop-in cold pans on the operator side. Vertical glass protector guard with stainless steel posts are mounted to a stainless steel workboard surface, along with a removable zip lite cutting board. Available with a choice of standard grade plastic laminate exterior ends.



MODEL	L	D	H
SCRFCAIR-SSII	48"	48"	54.58"
SCRFCZR-SSII	72"	48"	54.58"

SPECIAL FEATURES

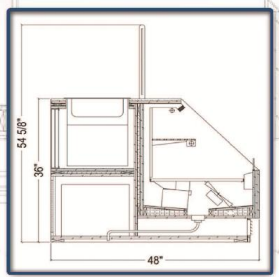

REAR DROP-IN HOT COLD PANS

OPTIONAL STAINLESS STEEL EXTERIOR FINISH AVAILABLE 53.



STRATUS III AIR SCREEN



The Stratus III Air Screen SCRFC-SSIII Series is designed as a self-select grab and go refrigerator in the front with rear drop-in hot food wells on the operator service side. Vertical glass protector guard with stainless steel posts are mounted to a stainless steel workboard surface, along with a removable zip lite cutting board. Available with a choice of standard grade plastic laminate exterior ends.

MODEL	L	D	H
SCRFC60R-SSIII	48"	48"	54 5/8"
SCRFC72R-SSIII	72"	48"	54 5/8"

SPECIAL FEATURES

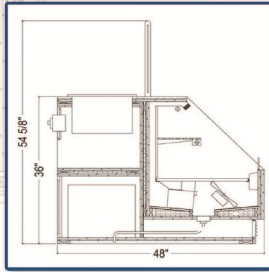

DROP-IN HOT FOOD WELLS WITH REAR CONTROLS

54. OPTIONAL STAINLESS STEEL EXTERIOR FINISH AVAILABLE



EXPRESS SELF-SELECT MONACO COLD

The Express Monaco Cold SCXSSC Series is a self-select refrigerated open air display case with choice of standard grade plastic laminate exterior ends and features a 12" wide stainless steel work surface. Optional stainless steel exterior finish, special laminates and wood veneers are also available, with a choice of casters or adjustable legs.

MODEL	L	D	H
SCXSSC46R	47 3/8"	43 7/8"	37 1/8"
SCXSSC60R	59 3/8"	43 7/8"	37 1/8"
SCXSSC72R	71 3/8"	43 7/8"	37 1/8"
SCXSSC96R	91 3/4"	43 7/8"	37 1/8"



CONSULT FACTORY FOR ADDITIONAL INFORMATION

SPECIAL FEATURES



12" WIDE STAINLESS STEEL
WORK SURFACE



OPTIONAL STAINLESS STEEL
STEP PLATE

CONTINENTAL BAKERY CR

The Continental Bakery SCCB-CR Series is a two compartment bakery display case consisting of a refrigerated service top section and a refrigerated self-service bottom section. Available with a choice of standard grade plastic laminate exterior ends. The lower section has stainless steel deck pan(s) with a raised fitted hemmed edge to contain spills. Deck pan can be removed for easy cleaning.

MODEL	L	D	H
SCCB36R-CR	36"	35 3/4"	54"
SCCB48R-CR	48"	35 3/4"	54"
SCCB60R-CR	60"	35 3/4"	54"
SCCB72R-CR	72"	35 3/4"	54"

IDEAL FOR BAKERY & BEVERAGE
GRAB & GO DISPLAY



REFRIGERATED TOP

CONTINENTAL BAKERY CS

The Continental Bakery SCCB-CS Series is a three compartment bakery display case consisting of a refrigerated self-serve lower section and a service refrigerated and non-refrigerated split upper section. The lower section has stainless steel deck pan(s) with a raised fitted hemmed edge to contain spills. The deck pan can be removed for easy cleaning. The upper section is a split display area with one side refrigerated and one side non-refrigerated with glass shelves and a T5 fluorescent top canopy light.

MODEL	L	D	H
SCCB36R-CS	36"	35 3/4"	54"
SCCB48R-CS	48"	35 3/4"	54"
SCCB60R-CS	60"	35 3/4"	54"
SCCB72R-CS	72"	35 3/4"	54"



REFRIGERATED / NON-REFRIGERATED TOP



CONTINENTAL BAKERY CD

The Continental Bakery SCCB-CD Series is a two compartment bakery display case consisting of a non-refrigerated service top section and a refrigerated self-service bottom section. Available with a choice of standard grade plastic laminate exterior ends. The lower section has stainless steel deck pan(s) and a raised fitted hemmed edge to contain spills. Deck pan can be removed for easy cleaning.

MODEL	L	D	H
SCCB36R-CD	36"	35 3/4"	54"
SCCB48R-CD	48"	35 3/4"	54"
SCCB60R-CD	60"	35 3/4"	54"
SCCB72R-CD	72"	35 3/4"	54"



NON-REFRIGERATED TOP

EXPRESS BAKERY OPEN AIR

The Express Bakery Open Air SCXSSB Series is a self-service refrigerated display case with a choice of standard grade plastic laminate exterior ends. Optional special laminates and wood veneers are also available, with a choice of casters or adjustable legs. Pull down night curtain is also available as an optional feature.

MODEL	L	D	H
SCXSSB46R-SC	45 7/8"	37 1/2"	59 1/2"
SCXSSB60R-SC	57 7/8"	37 1/2"	59 1/2"
SCXSSB72R-SC	69 7/8"	37 1/2"	59 1/2"



CONSULT FACTORY FOR ADDITIONAL INFORMATION 



CONTINENTAL BAKERY OU



IDEAL FOR BAKERY & BEVERAGE
GRAB & GO DISPLAY

The Continental Bakery Over / Under SCCB-OU Series is a two section bakery display case featuring a refrigerated operator serve lower section and a non-refrigerated service upper section. Available with a choice of standard grade plastic laminate exterior ends. The lower section has a lift-up laminated deck that can be removed for easy cleaning.

MODEL	L	D	H
SCCB66R-OU	36"	35 3/4"	60"
SCCB48R-OU	48"	35 3/4"	60"
SCCB60R-OU	60"	35 3/4"	60"
SCCB72R-OU	72"	35 3/4"	60"

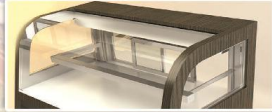

INSULATED GLASS VISION
END PANELS

SPECIAL FEATURES

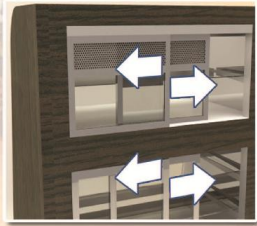

UPPER & LOWER REAR
SLIDING ACCESS DOORS

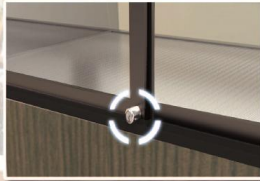

REAR DOOR LOCKS

RPI ADVANTAGE . . .



CUSTOMIZED ADVANTAGE



CONSULT FACTORY FOR ADDITIONAL INFORMATION 59.

RPI ADVANTAGE ... VIENNA AIR PAN SERIES

**REMOVABLE STAINLESS STEEL
EVAPORATOR COVER WITH HEMMED
EDGES TO CONTAIN SPILLS**

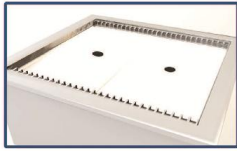

**REMOVABLE DECK PANS FOR EASY
CLEANING ACCESS**



**HOTEL PANS
(TO BE PROVIDED BY OTHERS)**

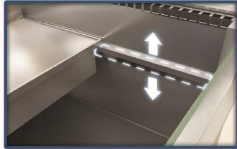

**OPTIONAL ADAPTER BARS
FOR STANDARD FULL-SIZE PANS OR
SLANTED DISPLAY (FANS ARE NOT INCLUDED)**



**UNIQUE LIFT-UP EVAPORATOR COIL
DESIGN FOR EASY CLEANING ACCESS**

60. CONSULT FACTORY FOR ADDITIONAL INFORMATION

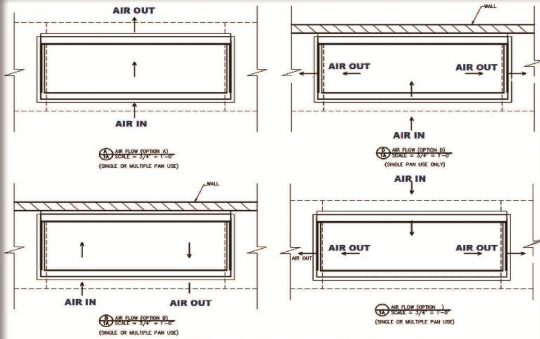

Air-Pan Refrigerator with Tower

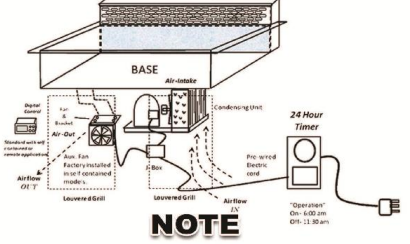

NOTE

AXIAL FAN MUST BE INSTALLED DIRECTLY BEHIND, AND AS CLOSE AS POSSIBLE TO THE REAR LOUVERED AIR GRILL IN THE COUNTER, ALONG WITH A PROPERLY INSTALLED TIRM COLLAR FOR PRECISE VENTILATION FROM THE AXIAL FAN, DIRECTLY THROUGH THE LOUVERED AIR GRILL. THIS ALSO ENSURES PROPER VENTILATION FOR THE CONDENSING UNIT.

USE SUPPLIED SELF-DRILLING SCREWS TO MOUNT AXIAL FAN TO THE UNDERSIDE OF THE AIR PAN BASE

RPI AIR TOWER

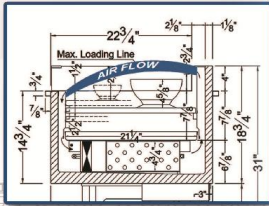

PRODUCT VISIBILITY AT COUNTER HEIGHT

**VERSUS OTHER COMPANIES
TRADITIONAL COLD WALL**

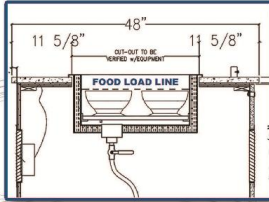

**PRODUCT VISIBILITY 3" BELOW COUNTER
DISPLAY**

62. CONSULT FACTORY FOR ADDITIONAL INFORMATION

RPI ADVANTAGE . . . VIENNA AIR PAN SERIES

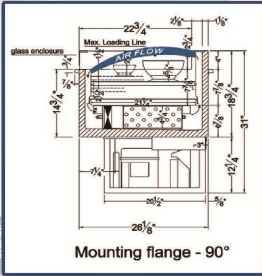

Mounting flange - 90°

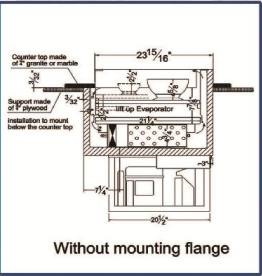

Without mounting flange

AIR TOWER



AIR FLOW

VIAP2 AT

**HIGHER AIR COVERAGE FOR TALLER PRODUCT
MORE PRODUCT AT A MORE APPEALING EYE LEVEL! 63.**



VIENNA SERIES - AIR PAN



VIAP2-0-R-SC

The Vienna Series VIAP is a drop-in air pan. It is cooled by circulating a curtain of refrigerated air over the product in the display area to enable precise temperature control and maximum cold transfer to the food product. Evaporator features a lift-up mechanism that allows the inner pan to be easily rinsed clean. Unit is designed to accommodate standard hotel / foodservice pans (to be purchased by others).

UNITS SHOWN WITH REMOVABLE DECK PANS AND OPTIONAL HOTEL PAN. FLOOR DRAIN REQUIRED



VIAP3-0-R-SC



VIAP4-0-R-SC



VIAP5-0-R-SC

MORE PRODUCT AT A MORE APPEALING EYE LEVEL!

SIZES & SPECIAL FEATURES

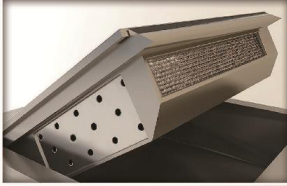

MODEL	L	D	H
VIAP2-0-R-SC	30 1/8"	27 7/8"	25 3/4"
VIAP3-0-R-SC	43 3/8"	27 7/8"	25 3/4"
VIAP4-0-R-SC	56 1/8"	27 7/8"	25 3/4"
VIAP5-0-R-SC	66 7/8"	27 7/8"	25 3/4"

LENGTHS INCLUDE OUTSIDE FLANGES

UNIQUE LIFT-UP EVAPORATOR COIL FOR EASY CLEANING ACCESS!



VIENNA SERIES - AIR PAN WITH AIR TOWER

The Vienna Series VIAP AT is a drop-in air pan with an air tower, which provides higher air coverage for taller product. It is cooled by circulating a curtain of refrigerated air over the product in the display area to enable precise temperature control and maximum cold transfer to the food product. Evaporator features a lift-up mechanism that allows the inner pan to be easily rinsed clean. Unit is designed to accommodate standard hotel / foodservice pans (to be purchased by others).



VIAP2-0-R-SC AT

UNITS SHOWN WITH REMOVABLE DECK PANS AND OPTIONAL HOTEL PAN. FLOOR DRAIN REQUIRED



VIAP3-0-R-SC AT



VIAP4-0-R-SC AT

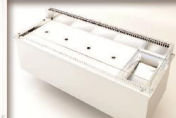

VIAP5-0-R-SC AT

PRODUCT VISIBILITY AT COUNTER HEIGHT!

SIZES & SPECIAL FEATURES

MODEL	L	D	H*
VIAP2-0-R-SC AT	30 1/8"	27 7/8"	29 1/8"
VIAP3-0-R-SC AT	43 3/8"	27 7/8"	29 1/8"
VIAP4-0-R-SC AT	56 1/8"	27 7/8"	29 1/8"
VIAP5-0-R-SC AT	68 7/8"	27 7/8"	29 1/8"

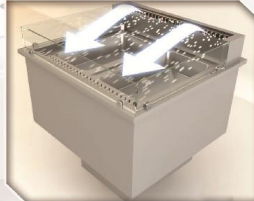

LENGTHS INCLUDE OUTSIDE FLANGES

* 29 1/8" O.A. height, includes 4" height of the air tower. Contact factory for cut out and installation information.

HIGHER AIR COVERAGE FOR TALLER PRODUCT! 65.



VIENNA SERIES - AIR PAN (SLANT)

VIAP3-0-R-SC (SLANT)



The Vienna Series VIAP Slant Display is a slide-in style air pan unit. It is cooled by circulating a curtain of refrigerated air over the product in the display area to enable precise temperature control and maximum cold transfer to the food product. Evaporator features a lift-up mechanism that allows the inner pan to be easily rinsed clean. Unit is designed to accommodate standard hotel / food service pans (to be purchased by others) and features adjustable deck pans for slant presentation.

UNITS SHOWN WITH OPTIONAL PANS, ADAPTER BARS AND CASTERS

VIAP4-0-R-SC (SLANT)

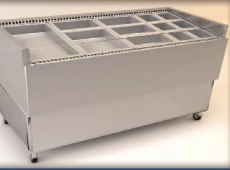

VIAP5-0-R-SC (SLANT)



SPECIAL FEATURES & SIZES

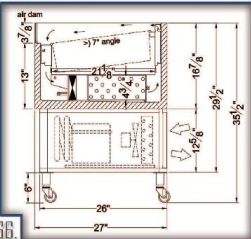

MODEL	L	D	H
VIAP3-0-R-SC (SLANT)	41 3/8"	27"	29 1/2"
VIAP4-0-R-SC (SLANT)	54 1/8"	27"	29 1/2"
VIAP5-0-R-SC (SLANT)	66 7/8"	27"	30 3/8"

CONSULT FACTORY FOR ADDITIONAL INFORMATION



VIENNA SERIES - AIR PAN (SLANT EXTRA DEEP)

The Vienna Series VIAP Slant Extra Deep Display is a slide-in style extra deep air pan unit. It is cooled by circulating a curtain of refrigerated air over the product in the display area to enable precise temperature control and maximum cold transfer to the food product. Evaporator features a lift-up mechanism that allows the inner pan to be easily rinsed clean. Unit is designed to accommodate standard hotel / food service pans and features an extra row for 1/3 size pans (to be purchased by others), along with adjustable deck pans for slant presentation.



VIAP3-0-R-SC (SLANT EXTRA DEEP)

UNITS SHOWN WITH OPTIONAL PANS, ADAPTER BARS AND CASTERS



VIAP5-0-R-SC (SLANT EXTRA DEEP)

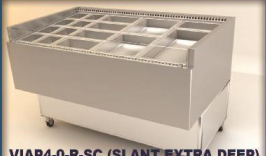

VIAP4-0-R-SC (SLANT EXTRA DEEP)

SPECIAL FEATURES & SIZES

MODEL	L	D	H
VIAP3-0-R-SC (SLANT EXTRA DEEP)	41 3/8"	33 7/8"	29 1/2"
VIAP4-0-R-SC (SLANT EXTRA DEEP)	54 1/8"	33 7/8"	29 1/2"
VIAP5-0-R-SC (SLANT EXTRA DEEP)	66 7/8"	33 7/8"	30 3/8"

CONSULT FACTORY FOR ADDITIONAL INFORMATION

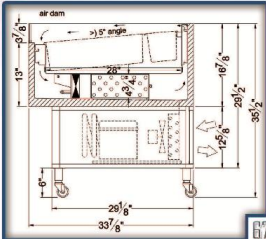

RPI ADVANTAGE ... VIENNA AIR PAN SERIES

SLANTED DISPLAY AIR PANS

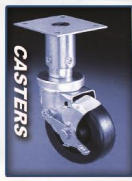

CASTERS

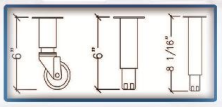

STYLE #1 STYLE #2 STYLE #3

OPTIONAL



LEG/BULLET FEET

CUSTOMIZED ADVANTAGE

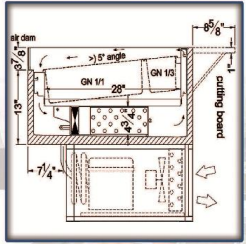

REAR CUTTING UTILITY BOARD

OPTIONS SHOWN AVAILABLE FOR VIENNA AIR PAN SLIDE-IN STYLE UNITS

CONSULT FACTORY FOR ADDITIONAL INFORMATION



ADVANTAGE . . . VIENNA AIR PAN SERIES



VARIOUS INSTALLATIONS



**EXTRA DEEP ALLOWS FOR
ADDITIONAL PRODUCT MERCHANDISING!**

SLANTED DISPLAY AIR PANS

69.



VIENNA SERIES - AIR PAN CURVED



VIAP2-0-R-CV-SC

The Vienna Series VIAP-CV is a drop-in air pan featuring a curved design. It is cooled by circulating a curtain of refrigerated air over the product in the display area to enable precise temperature control and maximum cold transfer to the food product. Evaporator features a lift-up mechanism that allows the inner pan to be easily rinsed clean. Unit is designed to accommodate standard hotel / foodservice pans (to be purchased by others).

UNITS SHOWN WITH HOTEL FOOD SERVICE PANS PROVIDED BY OTHERS. FLOOR DRAIN REQUIRED



VIAP3-0-R-CV-SC



VIAP4-0-R-CV-SC



VIAP5-0-R-CV-SC

SIZES & SPECIAL FEATURES



MODEL	L	D	H
VIAP2-0-R-CV-SC	38 3/8"	28"	25 3/4"
VIAP3-0-R-CV-SC	55 1/4"	28"	25 3/4"
VIAP4-0-R-CV-SC	71 5/8"	28"	25 3/4"
VIAP5-0-R-CV-SC	87 1/2"	28"	25 3/4"

LENGTHS INCLUDE OUTSIDE FLANGES

70. ABLE TO DROP-IN TO A CUSTOM COUNTER WITH VARIOUS BEAUTIFICATION OPTIONS AVAILABLE!



VIENNA SERIES - AIR PAN CURVED WITH AIR TOWER

The Vienna Series VIAP-CV AT is a drop-in air pan featuring a curved design with an air tower, which provides higher air coverage for taller product. It is cooled by circulating a curtain of refrigerated air over the product in the display area to enable precise temperature control and maximum cold transfer to the food product. Evaporator features a lift-up mechanism that allows the inner pan to be easily rinsed clean. Unit is designed to accommodate standard hotel / foodservice pans (to be purchased by others).



VIAP2-0-R-CV-SC AT

UNITS SHOWN WITH HOTEL FOOD SERVICE PANS PROVIDED BY OTHERS. FLOOR DRAIN REQUIRED



VIAP3-0-R-CV-SC AT



VIAP4-0-R-CV-SC AT



VIAP5-0-R-CV-SC AT

OPTIONAL FRONT AIR DAM GLASS PANEL SHOWN

SIZES & SPECIAL FEATURES

MODEL	L	D	H*
VIAP2-0-R-CV-SC AT	38 3/8"	28"	29 1/4"
VIAP3-0-R-CV-SC AT	53 1/4"	28"	29 1/4"
VIAP4-0-R-CV-SC AT	71 5/8"	28"	29 1/4"
VIAP5-0-R-CV-SC AT	87 1/2"	28"	29 1/4"

LENGTHS INCLUDE OUTSIDE FLANGES

CLEARANCE BETWEEN WELL AND COUNTER TOP 3/16" AT ALL SIDES

* 29 1/4" D.A. height, includes 4" height of the air tower. Contact factory for cut out and installation information.



SELECTION OF LOCATION WITHIN CLOSE PROXIMITY OF EXHAUST VENTILATORS AND DOORWAYS OR CEILING DUCTS CAN DISRUPT PERFORMANCE OF AIR FLOW

RPI

ADVANTAGE ... VIENNA AIR PAN SERIES

TILTED DISPLAY AIR PANS

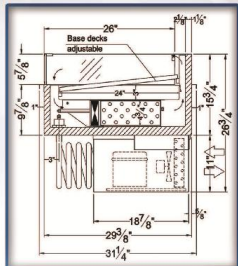

72.

CONSULT FACTORY FOR ADDITIONAL INFORMATION

RPI ADVANTAGE ... VIENNA AIR PAN SERIES



TILTED DISPLAY AIR PANS

VARIOUS INSTALLATIONS



SLOPED DISPLAY AIR PANS

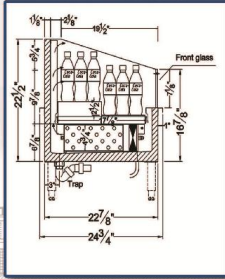

IDEAL FOR BEVERAGE DISPLAY!



AVAILABLE SIZES

MODEL	L	D	H
VIAP-2-0-R-SC BD	30 1/2"	24 3/4"	22 1/2"
VIAP-3-0-R-SC BD	43 1/4"	24 3/4"	22 1/2"
VIAP-4-0-R-SC BD	56"	24 3/4"	22 1/2"
VIAP-5-0-R-SC BD	68 3/4"	24 3/4"	22 1/2"

UNITS AVAILABLE IN CURVED OR STRAIGHT DISPLAY FORMATS!

SLOPED DISPLAY AIR PANS

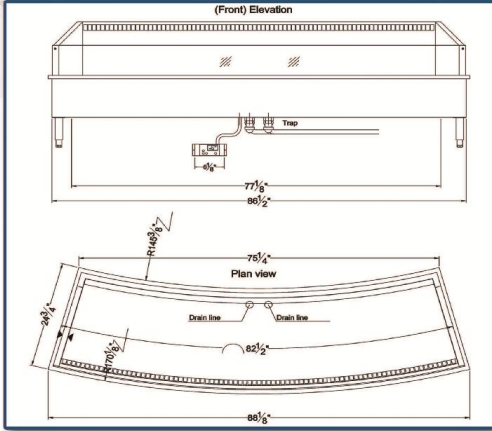

CONSULT FACTORY FOR
ADDITIONAL CUSTOMIZATION
OPTIONS!

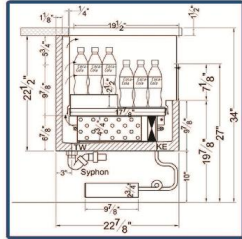

CUSTOMIZED ADVANTAGE

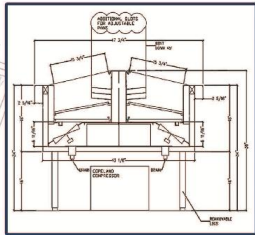
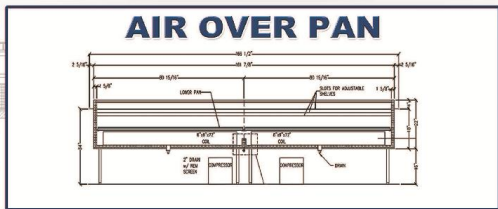
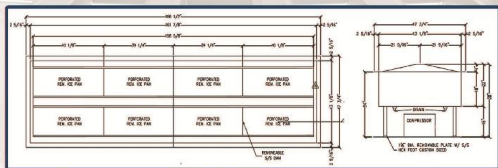

CAN BE PROVIDED WITH
ICE DISPLAY!

RPI ADVANTAGE . . . VIENNA AIR PAN SERIES



**CUSTOMIZED
ADVANTAGE**

BETTER VISUAL FOR PRODUCTS!

77.

CUSTOMIZED ADVANTAGE

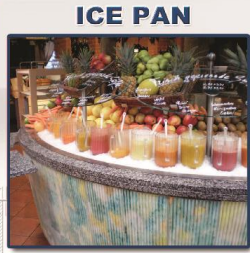
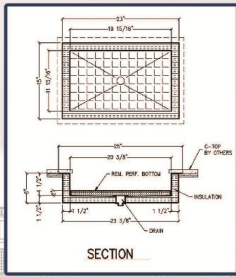

ICE PAN

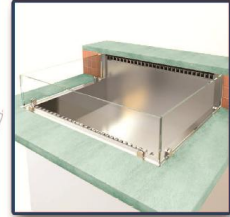
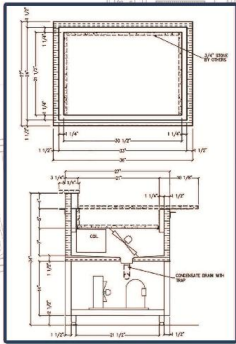

CUSTOM AIR TOWER

CUSTOMIZED ADVANTAGE

MAIN SERVING COUNTER

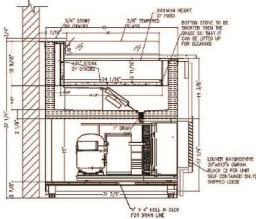

OPTION 1

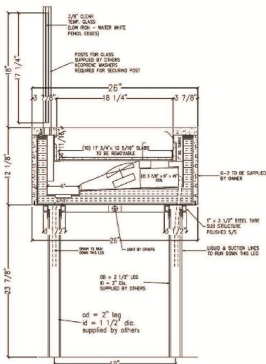
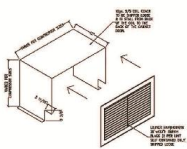

OPTION 2

RPI

ADVANTAGE . . . VIENNA AIR PAN SERIES



CUSTOMIZED ADVANTAGE

®

COLD WALL PAN

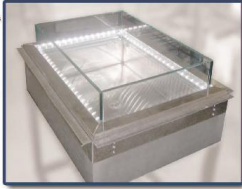
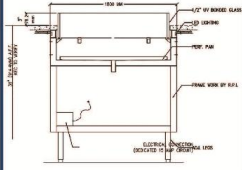

CONSULT FACTORY FOR ADDITIONAL INFORMATION

**SLANTED
COLD WALL PAN**

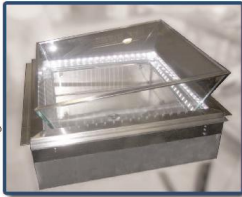
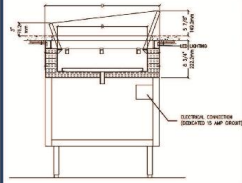

CUSTOMIZED ADVANTAGE



ADVANTAGE ... VIENNA AIR PAN SERIES

CUSTOMIZED ADVANTAGE

GLASS OR LEXAN AIR DAMS REQUIRED

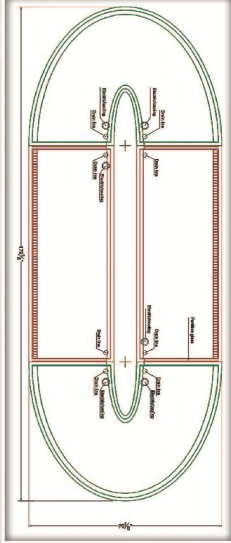
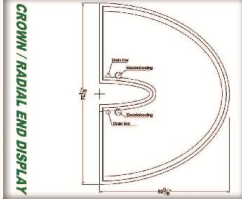
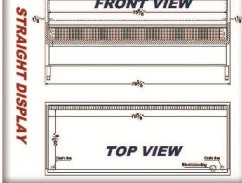
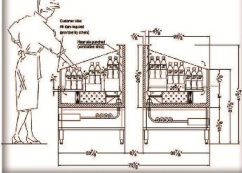

FOR BEVERAGES AND PRE-PACKAGED GOODS!

84. **CONSULT FACTORY FOR INSTALLATION INSTRUCTIONS**



VIENNA SERIES - LOB AIR



VIAP2-0-R-SC LOB

The Vienna Series VIAP LOB air pan is the ultimate in food presentation by offering a non-recessed refrigerated area that can be covered in quartz stone or solid surface material (MUST SPECIFY). The rear air plenum allows the refrigerated air pattern to "LOB" over the product up to 2 1/2 inches high. The unit is constructed in stainless steel, with a lift-up evaporator coil for easy cleaning.

UNITS SHOWN WITH 4TH 6 INCH AIR DAM GLASS PANEL (SERVICE/OPERATOR SIDE)



UNIQUE LIFT-UP EVAPORATOR

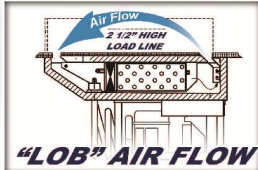

"LOB" AIR FLOW

ONLY AVAILABLE WITH RPI INTEGRATED COUNTER

SIZES & SPECIAL FEATURES

SELF CONTAINED

MODEL	L	D	H
VIAP-2-0-R-SC-LOB	31 7/8"	31 3/4"	17 7/8"
VIAP-3-0-R-SC-LOB	47 7/8"	31 3/4"	17 7/8"

REMOTE REFRIGERATED

MODEL	L	D	H
VIAP-2-0-R-RR-LOB	31 7/8"	31 3/4"	17 7/8"
VIAP-3-0-R-RR-LOB	47 7/8"	31 3/4"	17 7/8"



Optional Quartz Stone Surface!

CONSULT FACTORY FOR ADDITIONAL INFORMATION 85.

RPI

VIENNA SERIES - LOB AIR



***MUST BE BUILT INTO RPI MILLWORK TO
FUNCTION PROPERLY***



86.

***CONSULT FACTORY FOR ACCURATE COUNTER CONSTRUCTION
TO ACCOMMODATE LOB AIR***

RPI

VIENNA SERIES - LOB AIR



VARIOUS INSTALLATIONS



RPI

VIENNA SERIES - LOB AIR



VARIOUS INSTALLATIONS



88

RPI ADVANTAGE . . . VIENNA GRAB & GO SERIES



***HOT, COLD, AND DRY FOOD MERCHANDISING
OFFERING EXCEPTIONAL VISUAL APPEAL!***



***MULTIPLE OPTIONS ARE READILY AVAILABLE IN
CURVED RADIUS DISPLAY FOR SINGLE OR
MULTI-DECK PRESENTATIONS!***

RPI ADVANTAGE . . . VIENNA GRAB & GO SERIES



**REMOVABLE STAINLESS STEEL
EVAPORATOR COVER WITH HEMMED
EDGES TO CONTAIN SPILLS**

ADJUSTABLE GLASS SHELVES WITH LIGHTS

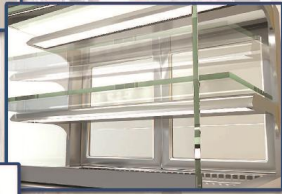

**REMOVABLE DECK PANS
FOR EASY CLEANING ACCESS**

**UNIQUE LIFT-UP EVAPORATOR COIL
DESIGN FOR EASY CLEANING ACCESS**



SI.

RPI

VIENNA SERIES - INSULATED GLASS AIR SCREEN



VARIOUS INSTALLATIONS



92. CONSULT FACTORY FOR ADDITIONAL INFORMATION



VIENNA SERIES - INSULATED GLASS AIR SCREEN

The Vienna Series VIAS-SQ INS Slide-in with rear air ventilation kit is a self-service "Grab and Go" style refrigeration merchandiser, featuring a choice of squared, slanted or curved glass profiles, with insulated glass side panels. Unit is available in choice of three heights with hinged rear see-through access doors. When being used as a "slide-in" please advise if counter height is 34" or 36". Optional 6" or 8" stainless steel adjustable legs or 6" casters are available for slide-in style models.



MODEL	L	D	H
VIAS2-20-R-SQ-SC-INS	31 1/2"	27 3/8"	20 7/8"
VIAS3-20-R-SQ-SC-INS	44 3/8"	27 3/8"	20 7/8"
VIAS4-20-R-SQ-SC-INS	57 1/8"	27 3/8"	20 7/8"
VIAS2-27-R-SQ-SC-INS	31 1/2"	27 3/8"	27 1/2"
VIAS3-27-R-SQ-SC-INS	44 3/8"	27 3/8"	27 1/2"
VIAS4-27-R-SQ-SC-INS	57 1/8"	27 3/8"	27 1/2"
VIAS2-34-R-SQ-SC-INS	31 1/2"	27 3/8"	34 1/4"
VIAS3-34-R-SQ-SC-INS	44 3/8"	27 3/8"	34 1/4"
VIAS4-34-R-SQ-SC-INS	57 1/8"	27 3/8"	34 1/4"

SLIDE-IN STYLE UNIT SHOWN WITH REAR AIR VENTILATION OPTION

NOTE: FLOOR DRAIN REQUIRED

AVAILABLE PROFILES



CURVED GLASS PROFILE



SLANTED GLASS PROFILE



SQUARED GLASS PROFILE



VIENNA SERIES - SLIDING DOORS



SLIDE-IN STYLE UNIT SHOWN WITH REAR AIR VENTILATION OPTION

The Vienna Series VICD-SQ SD Slide-In or Drop-in is a refrigerated display merchandiser, featuring insulated glass side panels and squared glass front with "sliding" access doors for self-serve application. Unit is available in choice of two heights with hinged rear see-through access doors. When being used as a "slide-in" please advise if counter height is 34" or 36". Optional 6" or 8" stainless steel adjustable legs or casters are available for slide-in style models.

MODEL	L	D	H
VICD2-26-R-SQ-SC SD	31 1/2"	27 3/8"	21 1/4"
VICD3-26-R-SQ-SC SD	44 1/4"	27 3/8"	21 1/4"
VICD4-26-R-SQ-SC SD	57 1/8"	27 3/8"	21 1/4"
VICD2-27-R-SQ-SC SD	31 1/2"	27 3/8"	28"
VICD3-27-R-SQ-SC SD	44 1/4"	27 3/8"	28"
VICD4-27-R-SQ-SC SD	57 1/8"	27 3/8"	28"

NOTE: FLOOR DRAIN REQUIRED

AVAILABLE PROFILES

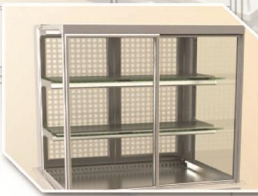

SQUARED GLASS PROFILE

SPECIAL FEATURES

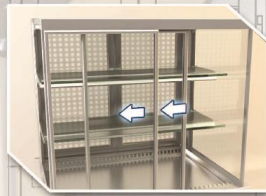

FRONT SLIDING ACCESS DOORS

EXCELLENT OPTION FOR AREAS WHERE AIR SCREENS MAY NOT WORK



VIENNA SERIES - SLIDING DOORS



CONSULT FACTORY FOR ADDITIONAL INFORMATION 95.



VIENNA SERIES - FLIP-UP DOORS



96. **CONSULT FACTORY FOR ADDITIONAL INFORMATION**



VIENNA SERIES - FLIP-UP DOORS

The Vienna Series VICD-SQ FD Slide-In with rear air ventilation kit is an attendant service refrigerated display merchandiser, featuring insulated glass top, side panels and a choice of squared, slanted and curved front profile with "flip-up" compartment access doors for self-serve application. Unit is available in choice of three heights with hinged rear see-through access doors. When being used as a "slide-in" please advise if counter height is 34" or 36". Optional 6" or 8" stainless steel adjustable legs or 6" casters are available for slide-in style models.

MODEL	L	D	H
VICD3-20-R-SQ-SC FD	31 1/2"	27 3/8"	21 1/4"
VICD3-20-R-SQ-SC FD	44 3/8"	27 3/8"	21 1/4"
VICD4-20-R-SQ-SC FD	57 1/8"	27 3/8"	21 1/4"
VICD3-27-R-SQ-SC FD	31 1/2"	27 3/8"	28"
VICD3-27-R-SQ-SC FD	44 3/8"	27 3/8"	28"
VICD4-27-R-SQ-SC FD	57 1/8"	27 3/8"	28"
VICD3-34-R-SQ-SC FD	31 1/2"	27 3/8"	34 5/8"
VICD3-34-R-SQ-SC FD	44 3/8"	27 3/8"	34 5/8"
VICD4-34-R-SQ-SC FD	57 1/8"	27 3/8"	34 5/8"



SLIDE-IN STYLE UNIT, SHOWN WITH REAR AIR VENTILATION OPTION

NOTE: FLOOR DRAIN REQUIRED

AVAILABLE PROFILES



CURVED GLASS PROFILE



SLANTED GLASS PROFILE



SQUARED GLASS PROFILE

RPI ADVANTAGE . . . VIENNA GRAB & GO SERIES



OPTIONAL CASTERS VS LEGS / BULLET FEET

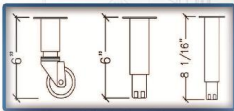

STYLE #1 STYLE #2 STYLE #3



OPTIONAL

98. **CONSULT FACTORY FOR ADDITIONAL INFORMATION**

RPI ADVANTAGE . . . VIENNA GRAB & GO SERIES

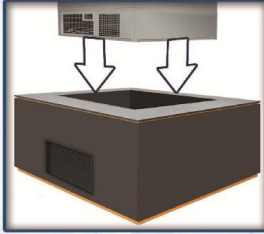

SLIDE-IN STYLE VS DROP-IN STYLE



DROP-IN STYLE NOTE
LOUVERED GRILL REQUIRED WITHIN REAR
OF COUNTER CONSULT FACTORY FOR SIZING.

INTERNAL COLLOR REQUIRED FOR PROPER AIRFLOW

CONSULT FACTORY FOR ADDITIONAL INFORMATION 99.

MODULAR WALLS



DECORATIVE PANELS



100. **CONSULT FACTORY FOR ADDITIONAL INFORMATION**

RPI ADVANTAGE... VIENNA GRAB & GO SERIES



CUSTOM COUNTERS



MODULAR COUNTERS

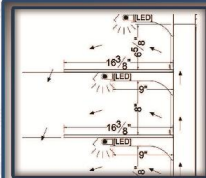

**OPTIONAL ENERGY
EFFICIENT LED LIGHTING!**

CONSULT FACTORY FOR ADDITIONAL INFORMATION 101

RPI ADVANTAGE . . . VIENNA GRAB & GO SERIES

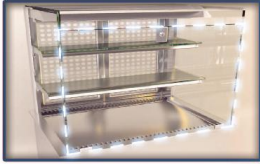

ACRYLIC LOCKING NIGHT COVER



LOCKABLE HINGED REAR ACCESS DOORS



VIAS2-20-R-CV-SC-SB



VIAS2-20-R-SL-SC-SB



VIAS2-20-R-SC-SC-SB

SOLID BACK DISPLAYS

FRONT BREATHING PANEL REQUIRED IF UNITS ARE INSTALLED AGAINST A WALL

UNITS AVAILABLE IN 20", 27" & 34" HEIGHTS

INSULATED GLASS AVAILABLE IN 34" HEIGHT ONLY FOR SOLID BACK DISPLAYS

102. CONSULT FACTORY FOR ADDITIONAL INFORMATION

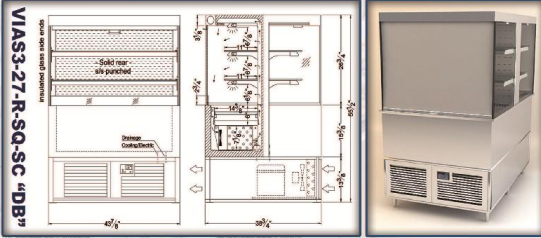

DOUBLE SIDED DISPLAY

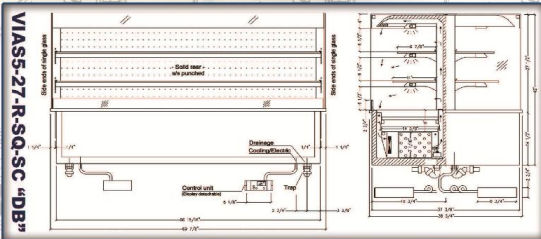

AVAILABLE IN SELF-CONTAINED & REMOTE REFRIGERATION

**SHELVES ADJUSTABLE IN 1 INCH HEIGHT AND 1 INCH IN ANGLE
AVAILABLE AS SLIDE-IN OR DROP-IN UNITS**

CONSULT FACTORY FOR ADDITIONAL INFORMATION 103.

RPI

VIENNA HOT DISPLAY



The Vienna Series VHD-SQ-CO is a slide-in self-service open heated display merchandiser, featuring infrared heaters and base heaters to provide a uniform cabinet temperature, which is controlled by a dial thermostat for desired temperature. Cabinet temperature is adjustable and ranges from 150 to 185 degrees Fahrenheit. The exterior is tempered glass and includes hinged rear doors. Aside from the squared, slanted, and curved glass profiles, this model is also available in a variety of lengths and heights. Please advise counter height is 34" or 36". Optional 6" or 8" stainless steel adjustable legs or 8" casters are also available. Designed for packaged foods only.

MODEL	L	D	H
VHD3-26-R-SQ-CO	31 1/2"	27 3/8"	20 7/8"
VHD3-26-R-SQ-CO	44 3/8"	27 3/8"	20 7/8"
VHD4-26-R-SQ-CO	57 1/8"	27 3/8"	20 7/8"
VHD3-27-R-SQ-CO	31 1/2"	27 3/8"	27 1/2"
VHD3-27-R-SQ-CO	44 3/8"	27 3/8"	27 1/2"
VHD4-27-R-SQ-CO	57 1/8"	27 3/8"	27 1/2"
VHD3-34-R-SQ-CO	31 1/2"	27 3/8"	34 1/4"
VHD3-34-R-SQ-CO	44 3/8"	27 3/8"	34 1/4"
VHD4-34-R-SQ-CO	57 1/8"	27 3/8"	34 1/4"

AVAILABLE PROFILES



CURVED GLASS PROFILE



SLANTED GLASS PROFILE



SQUARED GLASS PROFILE

104. CONSULT FACTORY FOR ADDITIONAL INFORMATION

RPI ADVANTAGE ... VIENNA HOT DISPLAY



REAR MOUNTED TEMPERATURE CONTROLS



ADJUSTABLE BLACK GLASS SHELVING



HINGED REAR SEE-THROUGH ACCESS DOORS



OPTIONAL REAR CUTTING UTILITY BOARD



INFRARED HEATING UNITS

ADDITIONAL OPTIONS

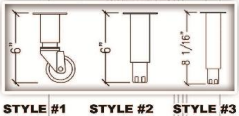

OPTIONAL



CONSULT FACTORY FOR ADDITIONAL INFORMATION



VIENNA SERIES - COUNTER TOP GRAB & GO



The Vienna Series VIAS-SQ CT is a refrigerated self-service air screen style unit designed for counter top application, featuring insulated square glass top and glass side panels. Units are standard in stainless steel with an adjustable shelf, lights and sliding rear see-through access doors.

MODEL	L	D	H
VIAS2-20-R-SQ-SC CT	31 1/2"	32 5/8"	28"

NOTE: FLOOR DRAIN REQUIRED

SPECIAL FEATURES



6' CORD & PLUG



SLIDING REAR-ACCESS DOORS



106.



VIENNA SERIES - COUNTER TOP GRAB & GO



**IDEAL MERCHANDISING SOLUTION
FOR COUNTER TOP APPLICATION!**



**CONVENIENT REAR DOOR
ACCESS FOR EASY STOCKING!**

CONSULT FACTORY FOR ADDITIONAL INFORMATION 107.

RPI

VIENNA SERIES - ISLAND SERIES



The Vienna Island Series VI-IS includes (3) different styles: Open-Air, Closed Cold Display and Closed Dry Display. These models can be purchased and used individually or in any combination of the 3. They each include a stainless steel exterior, (2) tempered glass shelves with lights, top canopy light, rear fold down work ledge and hinged rear doors. Units are available in straight or curved style. Combinations of the two styles can also be created to better suit customer requirements.

FLOOR DRAIN REQUIRED

WEDGE MODULES



WEDGE MODELS	L	D	H
VIAS-34-R-SG-SG-IS WEDGE	59 1/8"	28 1/2"	51 1/2"
VICD-34-R-SG-SG-IS WEDGE	59 1/8"	28 1/2"	51 1/2"
VIDD-34-R-SG-SG WEDGE	59 1/8"	28 1/2"	51 1/2"

STRAIGHT MODULES



STRAIGHT MODELS	L	D	H
VIAS-34-R-SG-SG-IS	31 1/8"	22 5/8"	51 1/2"
VIAS-34-R-SG-SG-IS	47 3/4"	22 5/8"	51 1/2"
VIAS-34-R-SG-SG-IS	58 3/4"	22 5/8"	51 1/2"
VICD-34-R-SG-SG-IS	31 1/8"	22 5/8"	51 1/2"
VICD-34-R-SG-SG-IS	47 3/4"	22 5/8"	51 1/2"
VICD-34-R-SG-SG-IS	58 3/4"	22 5/8"	51 1/2"
VIDD-34-R-SG-IS	31 1/8"	22 5/8"	51 1/2"
VIDD-34-R-SG-IS	47 3/4"	22 5/8"	51 1/2"
VIDD-34-R-SG-IS	58 3/4"	22 5/8"	51 1/2"

**MIX AND MATCH MODULES TO
CREATE YOUR ULTIMATE FOOTPRINT!**

108. **CONSULT FACTORY FOR ADDITIONAL INFORMATION**



VIENNA SERIES - ISLAND SERIES

NUMEROUS UNIT COMBINATIONS AVAILABLE!



HOW A COMBO WORKS

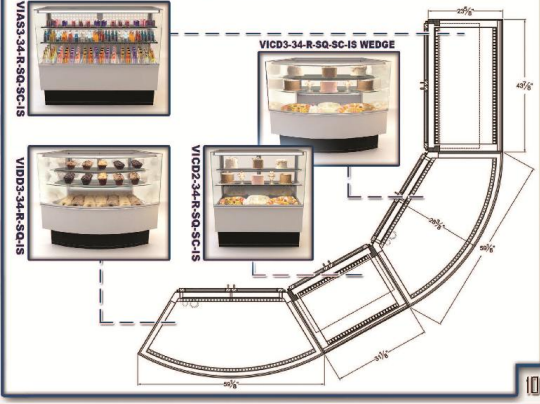

RPI

VIENNA SERIES - ISLAND SERIES

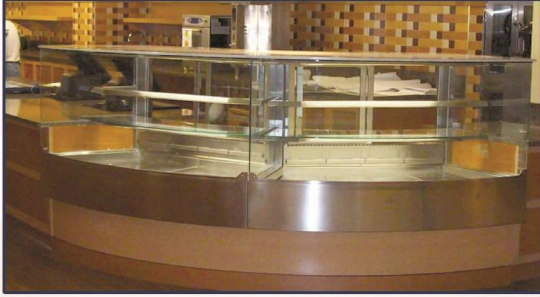

VARIOUS INSTALLATIONS



CONSULT FACTORY FOR ADDITIONAL INFORMATION

RPI

VIENNA SERIES - ISLAND SERIES



VARIOUS INSTALLATIONS



CONSULT FACTORY FOR ADDITIONAL INFORMATION



VIENNA SERIES - COLD COMBO



The Vienna Series VICC is a combination of our Vienna Grab N' Go and Cold Display. The upper display area is full service with (1) shelf with lights. Refrigerated deck area with non-refrigerated mezzanine shelf. The lower area features a self-service section and includes (1) refrigerated shelf with lights. The rear houses an area for cold pans and includes a sliding utility board. Designed to accommodate standard hotel / foodservice pans (to be purchased by others).

MODEL	L	D*	H
VICC-66-R-CV-SC	47 1/4"	51 5/8"	53 7/8"
VICC-66-R-CV-SC	60"	51 5/8"	53 7/8"
VICC-72-R-CV-SC	72 7/8"	51 5/8"	53 7/8"

NOTE: FLOOR DRAIN REQUIRED

SPECIAL FEATURES

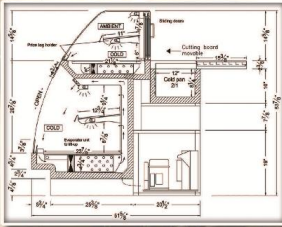

SLIDE-OUT CUTTING BOARD FOR PAN ACCESS

**Depth does not include slide-out cutting board. Add 15 3/8" in open position.*

RPI

VIENNA SERIES - COLD COMBO



VARIOUS INSTALLATIONS



CONSULT FACTORY FOR ADDITIONAL INFORMATION

RPI INDUSTRIES, INC.



HUSSMANN®

INTEGRATED INSTALLATIONS



Hussmann RMN Series



RPI Olympus Series

***Increase your
merchandising
flare by integrating
Hussmann
with RPI Series
displays!***

The Concept

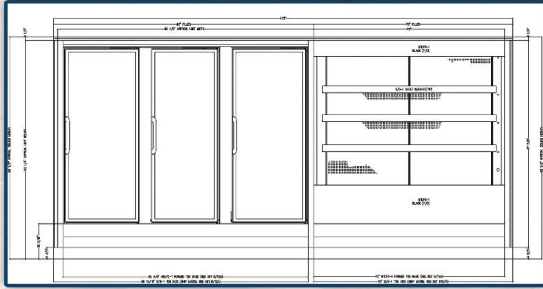

The Reality!

CONSULT FACTORY FOR ADDITIONAL INFORMATION

115

HUSSMANN®

RGD SERIES

LARGEST CAPACITY AIR SCREENS AVAILABLE!

The RGD, or Refrigerated Gondola Display Merchandiser is a grab & go case that comes in a variety of different sizes. It is available with a number of different "Husmann" paint and finish options, as well as a variety of shelving options.

These cases are also unique in that they can be utilized to refrigerate numerous different types of products ranging from floral, food, beverage, dairy, deli, and produce.

Units are available in Self-Contained or Remote Refrigeration



UNIT SHOWN WITH OPTIONAL GLASS VIEW ENDS

* REMOTE LENGTHS INCLUDE OPTIONAL END PANELS

REMOTE	L"	D	H
RGD24-72-3-3	47 3/4"	25"	73 5/8"
RGD24-72-4	50 1/4"	25"	73 5/8"
RGD24-72-5	62 1/4"	25"	73 5/8"
RGD24-72-6	74 1/4"	25"	73 5/8"
RGD24-72-8	98 1/4"	25"	73 5/8"
RGD24-72-10	122 1/4"	25"	73 5/8"
RGD24-72-12	146 1/4"	25"	73 5/8"
RGD24-83-3-3	47 3/4"	25"	84 5/8"
RGD24-83-4	50 1/4"	25"	84 5/8"
RGD24-83-5	62 1/4"	25"	84 5/8"
RGD24-83-6	74 1/4"	25"	84 5/8"
RGD24-83-8	98 1/4"	25"	84 5/8"
RGD24-83-10	122 1/4"	25"	84 5/8"
RGD24-83-12	146 1/4"	25"	84 5/8"
RGD30-72-3-3	47 3/4"	31"	73 5/8"
RGD30-72-4	50 1/4"	31"	73 5/8"
RGD30-72-5	62 1/4"	31"	73 5/8"
RGD30-72-6	74 1/4"	31"	73 5/8"
RGD30-72-8	98 1/4"	31"	73 5/8"
RGD30-72-10	122 1/4"	31"	73 5/8"
RGD30-72-12	146 1/4"	31"	73 5/8"
RGD30-83-3-3	47 3/4"	31"	84 5/8"
RGD30-83-4	50 1/4"	31"	84 5/8"
RGD30-83-5	62 1/4"	31"	84 5/8"
RGD30-83-6	74 1/4"	31"	84 5/8"
RGD30-83-8	98 1/4"	31"	84 5/8"
RGD30-83-10	122 1/4"	31"	84 5/8"
RGD30-83-12	146 1/4"	31"	84 5/8"

SELF-CONTAINED

L	D	H	
RGD24-72-3-3-SC	47 3/4"	24 1/4"	85 3/8"
RGD24-72-4-SC	50 1/4"	24 1/4"	85 3/8"
RGD24-72-5-SC	62 1/4"	24 1/4"	85 3/8"
RGD24-72-6-SC	74 1/4"	24 1/4"	85 3/8"
RGD24-72-8-SC	98 1/4"	24 1/4"	85 3/8"
RGD24-72-10-SC	122 1/4"	24 1/4"	85 3/8"
RGD24-72-12-SC	146 1/4"	24 1/4"	85 3/8"
RGD30-72-3-3-SC	47 3/4"	30 1/4"	85 3/8"
RGD30-72-4-SC	50 1/4"	30 1/4"	85 3/8"
RGD30-72-5-SC	62 1/4"	30 1/4"	85 3/8"
RGD30-72-6-SC	74 1/4"	30 1/4"	85 3/8"
RGD30-72-8-SC	98 1/4"	30 1/4"	85 3/8"
RGD30-72-10-SC	122 1/4"	30 1/4"	85 3/8"
RGD30-72-12-SC	146 1/4"	30 1/4"	85 3/8"

72" HIGH UNITS OFFERED WITH UP TO 5 OPTIONAL ROWS OF SHELVES

83" HIGH UNITS OFFERED WITH UP TO 7 OPTIONAL ROWS OF SHELVES

24" CLEARANCE REQUIRED BETWEEN CEILING AND TOP OF THE RGD UNITS FOR PROPER COMPRESSOR AIRFLOW

HUSSMANN®

RGDC SERIES



The RGDC, or Refrigerated Gondola Display Curved Merchandiser is a grab & go case that comes in one size, and is also available with a number of different "Hussmann" paint and finish options.

These cases are also unique in that they can be utilized to refrigerate numerous different types of products ranging from floral, food, beverage, dairy, deli, and produce.

Units are available in Self-Contained or Remote Refrigeration

REMOTE	L*	D	H
RGDC24-72-4	47' 1/8"	37' 3/16"	72"
RGDC24-83-4	47' 1/8"	37' 3/16"	83"

SELF-CONTAINED	L	D	H
RGDC24-71-4-SC	47' 1/8"	37' 3/16"	72"

* REMOTE LENGTHS INCLUDE OPTIONAL END PANELS

UNIT SHOWN WITH OPTIONAL GLASS END PANELS

RGDC 24 RR

RGDC 24 SC

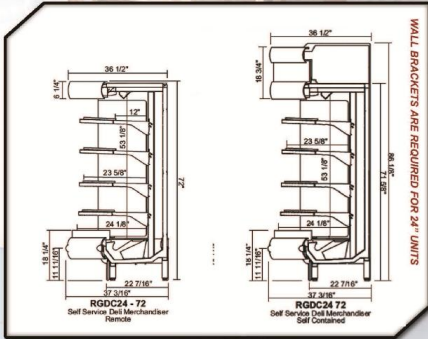

HUSSMANN®

RGD SERIES

REMOTE REFRIGERATED



RGD 24 RR



RGD 30 RR

**WALL BRACKETS ARE REQUIRED FOR 24" UNITS
(PROVIDED BY HUSSMANN)**

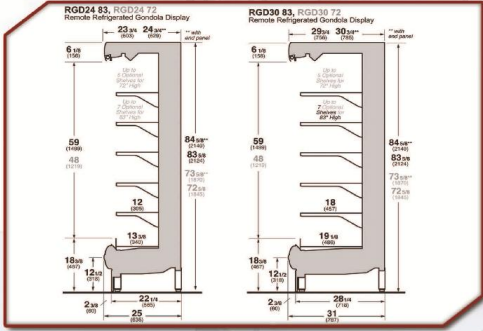

HUSSMANN®

RGD SERIES

RGD 24 SC



RGD 30 SC



SELF-CONTAINED

24" CLEARANCE REQUIRED BETWEEN CEILING AND TOP OF THE RGD UNITS FOR PROPER COMPRESSOR AIRFLOW

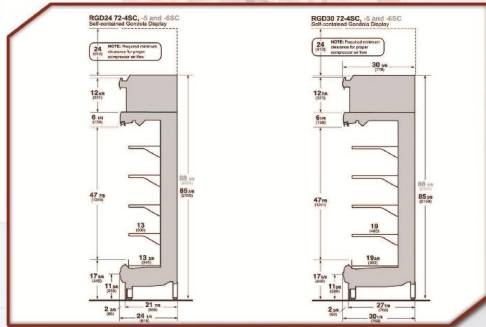

HUSSMANN®

RGD SERIES

SHELF SPACE COMPARISON



RGD 3072 vs SCAS72R

**RGD Series increases Shelf
Space over Conventional Size
Air Screens by 45%!**

120. CONSULT FACTORY FOR ADDITIONAL INFORMATION

HUSSMANN®

RGD SERIES



VARIOUS INSTALLATIONS



121

MULTI-DECK AND SINGLE-DECK SHOP AROUND ISLAND!

Advanced merchandising with lower energy cost!

- AVAILABLE IN MULTIPLE CASE WIDTHS, LENGTHS AND SHELVING OPTIONS, TO ACCOMMODATE MERCHANDISING AND FOOTPRINT NEEDS
- IDEAL FOR PREPARED SALADS, SANDWICHES, BEVERAGES AND VARIOUS GRAB & GO ITEMS
- SELF-CONTAINED OR REMOTE REFRIGERATION
- END UNITS AND CENTER MODULES AVAILABLE FOR CROWN END OR ISLAND CONFIGURATION



MERCHANDISING FLEXIBILITY

4', 5', or 6' widths and multiple lengths

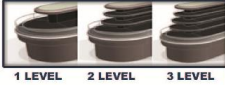

1 LEVEL 2 LEVEL 3 LEVEL

REDUCED ENERGY WITH ECOSHINE II LEDS!
Up to 69% energy savings when compared to fluorescent lighting!



Produce

Prepared Foods

Hot



Dairy

ENTYCE HAS THE SOLUTION FOR YOU!

Deli



Cheese



Beverages

Bakery



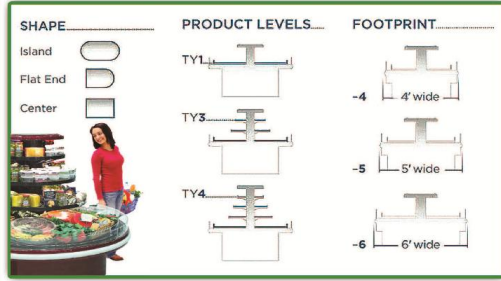

AVAILABLE SIZES

4' width	<p>TY3-4 3 levels Island Remote: 6', 8', 10', 12'; Self-Contained: 6', 8', 10' Flat End Remote: 4', 6', 8'; Self-Contained: 4', 6', 8'</p> <p>TY4-4 4 levels Island Remote: 6', 8', 10', 12'; Self-Contained: 6', 8', 10' Flat End Remote: 4', 6', 8'; Self-Contained: 4', 6', 8'</p>
5' width	<p>TY3-5 3 levels Island Remote: 7', 9', 11', 13', 15', 17'; Self-Contained: 7' Flat End Remote: 4', 6', 8'; Self-Contained: 4', 6', 8'</p> <p>TY4-5 4 levels Island Remote: 7', 9', 11', 13', 15', 17'</p>
6' width	<p>TY1-6 1 level Island Remote: 8', 12'</p> <p>TY3-6 3 levels Island Remote: 8', 10', 12', 14', 16', 18'; Self-Contained: 8', 10', 12' Flat End Remote: 8', 10', 12' Center Remote: 8'</p> <p>TY4-6 4 levels Island Remote: 8', 10', 12', 14', 16', 18' Flat End Remote: 8', 10', 12' Center Remote: 8'</p>

CONSULT FACTORY FOR ADDITIONAL INFORMATION

HUSSMANN®

ISLA SERIES

Isla Series features an "all-in-one-area" way to display refrigerated, dry and hot products, by offering a unique "design-your-own island" merchandiser configuration. A variety of modules and flexible layouts that include 3-sided, 2-sided, in-line and stand-alone cases are available to accommodate the ideal footprint.



Three new ISLA food counters have been launched as part of the new in-line offering. The ISLA cold counter contains refrigerated wells for self-serve salad and olive bars. ISLA's new in-line hot counter has individual well controls and an Automatic Waterfill system in the case (that fills and drains water without labor). And the ISLA soup counter has 11-quart soup wells and the Automatic Waterfill system as well. Each counter is available with either a wrap-around bumper or a flush-end option.

IM-R Isla Module:

Refrigerated Self Service Multi-Deck!

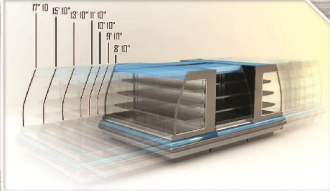

MODEL	L	D	H
IM-6405-C3-R	38 1/4"	33"	50 7/8"
IM-6405-C4-R	50 1/4"	33"	50 7/8"
IM-6405-C5-R	62 1/4"	33"	50 7/8"
IM-6405-C6-R	74 1/4"	33"	50 7/8"
IM-6405-C8-R	86 1/4"	33"	50 7/8"
IM-6405-C10-R	122 1/4"	33"	50 7/8"
IM-6405-C12-R	146 1/4"	33"	50 7/8"

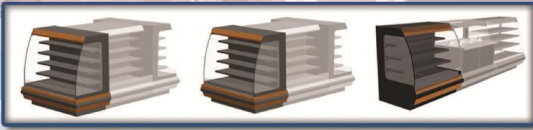

End and Center Modules for Island Configurations; Inline Modules for Stand-alone and Inline Configurations

Isla Standard Modules

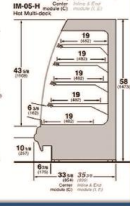
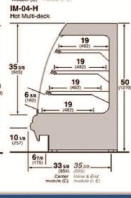
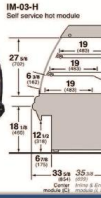
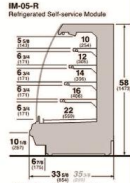
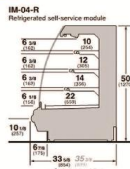

Flexible Layouts



Optional Heights

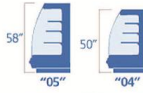

ISLA ALLOWS MORE THAN 100 CONFIGURATION OPTIONS!

CUSTOMIZE YOUR IDEAS AT STANDARD PRICING!

Choose Your Modules



HUSSMANN®

ISLA SERIES

Refrigerated Modules: sandwiches, cheese, deli, heat & serve...



Prepared Foods: hot & cold, soups, salads, coffee, cold drinks...



Specialized Modules: seafood, condiments, bakery, breads...



Dry Modules: bakery, produce, packaged items...



**NUMEROUS UNIT COMBINATIONS
AND STYLES AVAILABLE!**

HUSSMANN®

ISLA SERIES



MM-05-FH
18" Refrigerated Counter, 58" Height
MM-05-FH
18" Refrigerated Counter, 58" Height

MM-05-FH
18" Counter counter w/ Hot Water, 58" Height
MM-05-FH
18" Counter counter w/ Hot Water, 58" Height

MM-05-FH
18" Counter counter w/ Deep Wells, 58" Height
MM-05-FH
18" Counter counter w/ Deep Wells, 58" Height

MM-05-FD
18" Dry Counter, 58" Height
MM-05-FD
18" Dry Counter, 58" Height

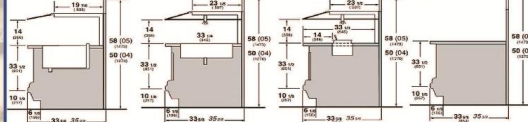

SPECIALIZED MODULES

MODULE OPTIONS

DELI

BAKERY

PREPARED FOODS

BEVERAGE

PRODUCE

SEAFOOD

MEAT

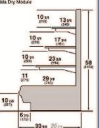
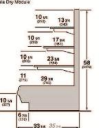
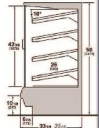
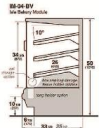

CONSULT FACTORY FOR ADDITIONAL INFORMATION 127

HUSSMANN®

ISLA SERIES



The Isla Series IM-H Module features a new "heat shelf" design, and hardcoat aluminum surface allowing for maintaining of even product temperatures. The module features individual digital thermostat controls for each shelf, aluminum framed doors for ease-of-access, and the new "heat shelves" feature drop-and-plug simplicity. Like the IM-R, the IM-H is available with a number of different sizes and configuration options.

IM-H Isla Module: Multi Deck Hot Display!

END MODEL	L	D	H
IM-0405-20-H	67 3/8"	33 3/8"	50" / 58"

CENTER MODEL	L	D	H
IM-0405-C3-H	38 1/4"	33 3/8"	50" / 58"
IM-0405-C4-H	50 1/4"	33 3/8"	50" / 58"
IM-0405-C5-H	62 1/4"	33 3/8"	50" / 58"
IM-0405-C6-H	74 1/4"	33 3/8"	50" / 58"

INLINE MODEL	L	D	H
IM-0405-I3-H	38 1/4"	33 3/8"	50" / 58"
IM-0405-I4-H	50 1/4"	33 3/8"	50" / 58"
IM-0405-I5-H	62 1/4"	33 3/8"	50" / 58"
IM-0405-I6-H	74 1/4"	33 3/8"	50" / 58"

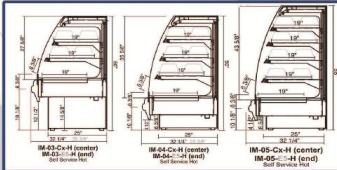

End and Center Modules for Island Configurations; Inline Modules for Stand-alone and Inline Configurations

HUSSMANN[®]

ISLA SERIES

**ISLA SERIES
ADVANTAGE**



SALAD DISPLAY MODULES



IM-FH SERIES

Units integrate seamlessly with various ISLA Series Modules!



IM-FR-SERIES

130. **Consult Factory for Additional Information**

HUSSMANN® ISLA SERIES

Energy Saving

- Optional night curtain increases efficiency by 12.6% if used 6 hrs. per day.
- Brake feature assures smooth closure.
- Concealed within canopy when not in use.



Island Port-O-Call

Entice your shoppers with variety of foods. Impulse buys, related products, seasonal tie-ins... Isla makes it easy to grow profits.

Reduced Installation Costs

Improved product quality with a factory unitized display. Superior fit and finish with factory installed finish panels.

Features and Benefits:

- Painted exterior
- Modular coil system – 5 year warranty
- Electronic ballast
- Energy efficient fans
- Solar digital thermometer

Food Safety and Shelf-Life

Superior performance and proven reliability with 5 year core component warranty.



ISLA SERIES ADVANTAGE

UNIQUE BUMPERLESS DISPLAYS AVAILABLE

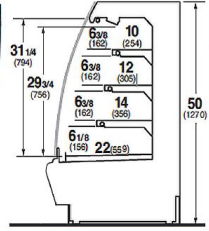

Consult Factory for Additional Information

HUSSMANN® THE Q SERIES

The "Q" Series lets you make foods look irresistible by displaying them with upscale style and flair. Your fresh, prepared foods will be showcased for maximum visual appeal. Use for prepared foods, deli selections, bakery offerings . . . hot or cold.

Q1-SS



Stylish curves combined with sleek design elements such as a plexiglass front create enhanced product visibility. The Q1-SS features granite or solid surface, which allows for an amazing merchandising display. Designed for ease of installation the Q1-SS has a simplified design that assures proper "fit" and does not require unsightly joint trim.

REMOTE	L	D	H	SELF-CONTAINED	L	D	H
Q1-4SS	50 1/2"	45"	34 1/8"	Q1-4SS-SC	50 1/4"	45"	46"
Q1-5SS	62 1/2"	45"	34 1/8"	Q1-5SS-SC	62 1/4"	45"	46"
Q1-6SS	74 1/2"	45"	34 1/8"	Q1-6SS-SC	74 1/4"	45"	46"
Q1-8SS	98 1/2"	45"	34 1/8"	Q1-8SS-SC	98 1/4"	45"	46"
Q1-10SS	122 1/2"	45"	34 1/8"				
Q1-12SS	146 1/2"	45"	34 1/8"				

Merchandising Flair!

SPECIAL FEATURES

WEDGE ASSEMBLY



WEDGE OPTIONS

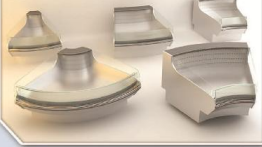

132. ADDITIONAL WEDGE OPTIONS AND ASSEMBLIES AVAILABLE CONSULT FACTORY FOR ADDITIONAL INFORMATION

HUSSMANN® THE Q SERIES

Q3-SS

The Q3-SS features a new 0° to 15° tilt shelf system, and allows for multiple rows, optional stop displays, and other flexible configurations. Solid surface front ledge and top add an elegant touch, and the LED lighting provides excellent product illumination.



Solid surface front ledge and top!

SELF-CONTAINED	L	D	H
Q3-455-SC	50 1/4"	45"	54"
Q3-555-SC	62 1/4"	45"	54"
Q3-655-SC	74 1/4"	45"	54"
Q3-855-SC	86 1/4"	45"	54"

REMOTE	L	D	H
Q3-455	50 1/4"	45"	54"
Q3-555	62 1/4"	45"	54"
Q3-655	74 1/4"	45"	54"
Q3-855	86 1/4"	45"	54"
Q3-1055	102 1/4"	45"	54"
Q3-1255	146 1/4"	45"	54"

SPECIAL FEATURES

WEDGE ASSEMBLY

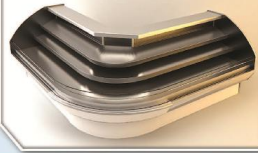

WEDGE OPTIONS



**ADDITIONAL WEDGE OPTIONS AND ASSEMBLIES AVAILABLE
CONSULT FACTORY FOR ADDITIONAL INFORMATION**

HUSSMANN® THE Q SERIES

Q3-SP



The Q3-SP provides superior flexibility for both merchandising and food preparation. A three level self-service display area topped off with various options for food prep will give you a complete food production and display environment. With the Q3-SP you can prepare, merchandise and sell deli items, pizzas, salads, sushi, meals-to-go and much more! Rear storage and various prep tops are just some of the many options available.

UNIT OFFERED AS
REMOTE REFRIGERATED ONLY

REMOTE	L	D	H
Q3-48P	50 1/4"	43 1/2"	39 1/2"
Q3-60P	62 1/4"	43 1/2"	39 1/2"
Q3-80P	74 1/4"	43 1/2"	39 1/2"
Q3-85P	88 1/8"	43 1/2"	39 1/2"
Q3-120P	108 1/4"	43 1/2"	39 1/2"

*Appealing display area
and prominent food
prep counter!*

SPECIAL FEATURES

WEDGE ASSEMBLY



WEDGE OPTIONS



**ADDITIONAL WEDGE OPTIONS AND ASSEMBLIES AVAILABLE
CONSULT FACTORY FOR ADDITIONAL INFORMATION**

HUSSMANN® THE Q SERIES



VARIOUS INSTALLATIONS



HUSSMANN® THE Q SERIES

DESIGN

Merchandising Flexibility
Develop solution to fit Operation needs

Increase Product Sales
Fresh Prepared foods made on-site to increase consumer confidence

Extend Product Shelf Life
- Superior Refrigeration Performance

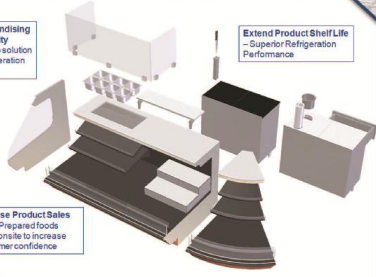

YOUR OWN

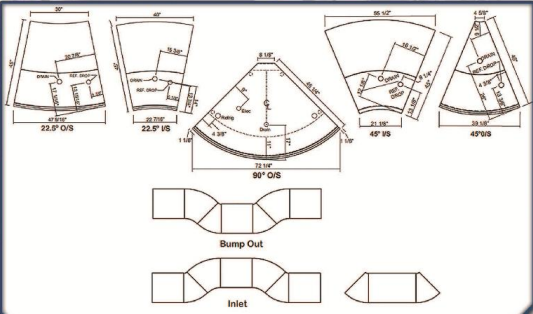

CONSULT FACTORY FOR ADDITIONAL INFORMATION

HUSSMANN® Impact Elite



E2

The E2 and E3 self-serve multi-decks can give you the perfect styling, performance and display capacity for your lower height, self-serve, specialty merchandising needs.

Dramatic appearance with uncompromising attention to detail is a hallmark of Impact Elite. Both E2 and E3 create a style and quality statement that adds value to the specialty shopping experience, helping you increase sales and customer loyalty.

The superior refrigeration and unmatched energy efficiency of Impact are now part of every Impact Elite Case. This advanced technology provides better product temperatures, longer shelf life, lower energy costs, fewer refrigerant leaks and easier cleaning and maintenance!

E3

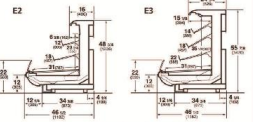

Note: Please use Hussmann's technical data sheets to get precise dimensions for all store layout purposes.

E2, E3 Plan Views

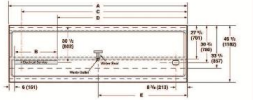

Dimension	A	B	C	D	E
4 foot	48 1/8 (1228)	26 1/8 (667)	9 5/8 (244)	6 (152)	24 1/2 (613)
6 foot	72 1/8 (1846)	26 1/8 (667)	41 (1041)	26 1/8 (667)	24 1/2 (613)
8 foot	96 1/8 (2464)	26 1/8 (667)	67 1/2 (1718)	26 1/8 (667)	24 1/2 (613)
10 foot	120 1/8 (3082)	26 1/8 (667)	93 1/2 (2382)	26 1/8 (667)	24 1/2 (613)

Note: Overall case height without ends or partitions.



Perfect styling, performance and display capacity for your lower height, self-serve, specialty merchandising needs!

137



This multi-level, self-serve design can present grab & go meals, deli products, pizza, cheeses and much more. Easily adjustable shelves, height and length options, lighting options, shelving options and wedge options all work to serve up your choice of superior merchandising features and capabilities.

REMOTE	L	D	H
E2S-4	50 1/8"	46 1/2"	41 3/4"
E2S-6	74 1/8"	46 1/2"	41 3/4"
E2S-8	98 1/4"	46 1/2"	41 3/4"
E2S-12	148 1/4"	46 1/2"	41 3/4"

Three Level Display for Deli, Cheese and Pizza!

E2SP

A three level self-service display area topped off with various options for food prep give you a complete food production and display environment.

Rear storage and various prep tops are just some of the many options available.



REMOTE	L	D	H
E2SP-4	50 1/8"	47"	40 1/4"
E2SP-6	74 1/8"	47"	40 1/4"
E2SP-8	98 1/4"	47"	40 1/4"
E2SP-12	148 1/4"	47"	40 1/4"

Features Unique Top Prep Area!

HUSSMANN® Impact Elite

E4

The E4 and E5 self-serve multi-decks can give you dramatic styling with excellent performance and display capacity for your taller self-serve, specialty merchandising needs.

Multi-Deck Displays for Deli, Pizza, Floral and Fresh Juice!



E5



Standard Lengths: 4', 6', 8', 12'

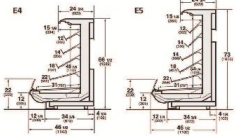

Note: Please see Husmann's technical data sheets to get precise dimensions for all sizes listed purposes.

E4, E5 Plan Views

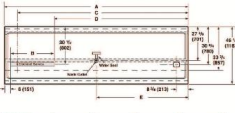

Dimension	A	B	C	D	E
4 foot	48 1/8 (1238)	38 1/8 (977)	6 5/8 (168)	6 (152)	24 1/2 (613)
6 foot	72 1/8 (1849)	38 5/8 (979)	43 (1093)	38 5/8 (979)	24 1/2 (613)
8 foot	96 1/8 (2460)	38 1/8 (977)	37 1/2 (941)	38 5/8 (979)	24 1/2 (613)
12 foot	144 3/8 (3687)	38 1/8 (977)	105 5/8 (2685)	102 1/4 (2600)	24 1/2 (613)

Note: Overall case length without ends or partitions

PLEASE CONSULT OUR FACTORY FOR MORE INFORMATION ON IMPACT ELITE SERIES

139

HUSSMANN® Impact Elite

E3-XC

The E3-XC self-serve multi-deck case gives you the perfect styling, performance and display capacity for your specialty merchandising needs.

The extended canopy can accommodate a peg display, allowing the flexibility of complementary hanging products. Up to three shelves can be flat or tilted to provide even more merchandising flexibility.



REMOTE	L	D	H
E3-4XC	50 1/2"	46 1/2"	55 7/8"
E3-6XC	74 1/2"	46 1/2"	55 7/8"
E3-8XC	98 1/2"	46 1/2"	55 7/8"
E3-12XC	146 1/2"	46 1/2"	55 7/8"

Multi-Deck Displays With Extended Canopy for Deli, Pizza, Prepared Foods or Produce!

E3S

Like the E3-XC, the E3S self-serve multi-deck cases give you the perfect styling, performance and display capacity for your specialty merchandising needs.

Dramatic appearance with uncompromising attention to detail is a hallmark of the Impact Elite Series. The E3S create a style and quality statement that adds value to the specialty shopping experience, helping you increase sales and customer loyalty.



REMOTE	L	D	H
E3S-4	50 1/2"	46 1/2"	54"
E3S-6	74 1/2"	46 1/2"	54"
E3S-8	98 1/2"	46 1/2"	54"
E3S-12	146 1/2"	46 1/2"	54"



PLEASE CONSULT OUR FACTORY FOR MORE INFORMATION ON IMPACT ELITE SERIES

HUSSMANN® *Excel*

B3XC-LEP



The B3XC-LEP is 4" deeper (front to back) than our standard Excel multi-deck fixtures. This allows higher volume display of deli items, grab and go foods, cheese, packaged produce and more.

The case is a medium height (59 7/8" tall) for easy shopping in higher volume departments. Interior merchandising space is 34 1/8" deep (front to back at lower deck) by 37 1/8" tall. Glass front is standard on the B3XC-LGEP model.

Modular coils and off-time defrost work to reduce thermal shock and stabilize product temperatures, resulting in better freshness and longer shelf life.

Bulk Convertible Merchandiser!
Displays High Volume of Products!

REMOTE	L	D	H
B3XC-4LEP	51 3/8"	46"	59 7/8"
B3XC-6LEP	75 3/8"	46"	59 7/8"
B3XC-8LEP	99 3/8"	46"	59 7/8"
B3XC-12LEP	147 1/2"	46"	59 7/8"

B3XC-LGEP

Superior Reliability!

Like its alternative, the B3XC-LGEP is 4" deeper (front to back) than our standard Excel multi-deck fixtures, allowing higher volume display of deli items, grab and go foods, cheese, packaged produce and more.

Unlike the B3XC-LEP however, the LGEP comes standard with front glass, resulting in a higher front end.



REMOTE	L	D	H
B3XC-4LGEP	51 3/8"	46"	59 7/8"
B3XC-6LGEP	75 3/8"	46"	59 7/8"
B3XC-8LGEP	99 3/8"	46"	59 7/8"
B3XC-12LGEP	147 1/2"	46"	59 7/8"

HUSSMANN® *Excel*

B4X-E

The B4X-E high-volume multi-deck is the newest case in Hussmann's bulk line-up. With four decks and an 82" height, the B4X-E can hold four layers of product for easy shopping in higher volume departments. It is 4" deeper (front to back) than our standard Excel multi-deck fixtures for maximum pack-out of bulk medium temp items. Interior merchandising space is 34 1/8" deep (front to back at lower deck) by 53 3/8" tall. Modular coils and off-time defrost work to reduce thermal shock and stabilize product temperatures, resulting in better freshness and longer shelf life!



Four-Deck Bulk Convertible Merchandiser for Higher Volume Display of Products!

REMOTE	L	D	H
B4X-6E	51 3/8"	46"	81 3/4"
B4X-8E	75 3/8"	46"	81 3/4"
B4X-9E	89 3/8"	46"	81 3/4"
B4X-10E	123 1/2"	46"	81 3/4"
B4X-12E	146 1/2"	46"	81 3/4"



C2X-X

The C2X-X provides quick, easy shopping access and can merchandise a wide variety of refrigerated foods. Ideal for grab-n-go meals or other high margin prepared food selections such as sandwiches, salads, pizza, etc.

REMOTE	L	D	H
C2X-4X	51 3/8"	42"	85 3/4"
C2X-6X	75 3/8"	42"	85 3/4"
C2X-8X	89 3/8"	42"	85 3/4"
C2X-12X	146 1/2"	42"	85 3/4"

Extra Height Multi-Deck Convertible Merchandiser!

Great Selection

HUSSMANN® Excel

CBX



The CBX is designed to help you sell product. It is a high capacity convertible merchandiser that can hold any medium temp product, from fresh meat to dairy to cut produce. Full view glass ends and stainless steel reflective ends are two excellent display options that assist in creating an endless product view. Shelves can be positioned at any height for greater merchandising flexibility. Optional lighted canopy signs can be utilized to announce specials, advertise brands, promote store slogans, and much more!

REMOTE	L	D	H
CBX-4	51 3/8"	42"	87 3/8"
CBX-5	75 3/8"	42"	87 3/8"
CBX-6	99 3/8"	42"	87 3/8"
CBX-8	147 1/2"	42"	87 3/8"

**High Capacity, Multi-Deck
Convertible Merchandiser!**

CBX-LRE



The CBX-LRE combines merchandising impact and capacity, and is designed to display dairy and deli products. The unit also features easy rear-loading from a cooler adjacent to the back of the case. This insures that product can be stocked quickly and stays cold. Overlapping sliding doors in each 4' section provide excellent access to the full merchandising area.

REMOTE	L	D	H
CBX-4LRE	51 3/8"	45 1/2"	87 1/2"
CBX-6LRE	75 3/8"	45 1/2"	87 1/2"
CBX-8LRE	99 3/8"	45 1/2"	87 1/2"
CBX-12LRE	147 1/2"	45 1/2"	87 1/2"

**Rear Load-In
for Dairy and Deli!**

**REAR-LOADING
ACCESS DOORS**

HUSSMANN® Excel

CR3D

This 3 zone merchandiser sets the pace for its segment. It allows for self-service, full service, and extra storage all in a small footprint. Having a full range of configurations atop a high-capacity self-service case, the R3 Family redefines what a merchandiser should be.

Heated air sweep reduces glass sweating maintaining a clear unobstructed view of product, and all-metal construction ensures a durable and reliable service life!



REMOTE	L	D	H
CR3D-4	50"	59 1/16"	53"
CR3D-5	62"	59 1/16"	53"
CR3D-6	74"	59 1/16"	53"
CR3D-8	98"	59 1/16"	53"
CR3D-10	122"	59 1/16"	53"
CR3D-12	146"	59 1/16"	53"

Ideal for Grab-N-Go meals or other high margin prepared food selections!

SPECIAL FEATURES

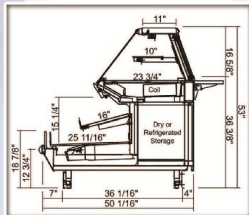

OPTIONAL SHELVES AND WRAPPING BOARD



OPTIONAL SLANTED TOP GLASS

HUSSMANN® *Excel*

CR3FO



This small self-service merchandiser can hold a large volume of product with a 26" lower deck and optional 12" and 18" shelves.

The CR3FO also features several "top" options including a dry upper dome, setup for a Moshizaki® Sushi display, a warming plate, or just a flat or prep top.

REMOTE	L	D	H
CR3FO-3	35 3/8"	33 1/2"	42"
CR3FO-4	47 3/4"	33 1/2"	42"

SELF-SERVICE, REMOTE UNIT
SHOWN WITH WARMING PLATE OPTION

Versatile Service Top and Self-Service Front Deli Merchandiser!

SPECIAL FEATURES



WARMING PLATE TOP OPTION



LOWER MOUNTED SELF-CONTAINED OPTION

HUSSMANN® Excel

CR3P

The CR3P is set-up to have several prep top options including a refrigerated condiment rail for food prep, warming plates for hot product sales, or a flat top for prep or display with multiple sneeze guard options.

REMOTE	L	D	H
CR3P-4	50"	50 1/16"	54"
CR3P-6	74"	50 1/16"	54"
CR3P-8	98"	50 1/16"	54"
CR3P-10	122"	50 1/16"	54"
CR3P-12	146"	50 1/16"	54"



Several Prep Top Options Available!

Refrigerated condiment rail for food prep, warming plates for hot product sales, or a flat top for prep or display with multiple sneeze guard options!

SPECIAL FEATURES



CURVED GLASS PROFILE



SLANTED GLASS PROFILE



SNEEZE GUARD

HUSSMANN® Excel

D5X-ULEP



The D5X-ULEP is an ultra low front dairy case that helps you create a total "Wall of Product" in your dairy/deli departments. Front height has been lowered until it is virtually even with the bottom display racks. Customers have a full view of all product facings, top to bottom. Now you can maximize the merchandising opportunity without increasing the footprint.

REMOTE	L	D	H
D5X-4LEP	51 3/8"	42"	83 1/4"
D5X-6LEP	75 3/8"	42"	83 1/4"
D5X-8LEP	99 3/8"	42"	83 1/4"
D5X-12ULEP	147 1/2"	42"	83 1/4"

Lower front deck offers full view of product facings top to bottom!

D6NX-LEP

The extra tall D6NX-LEP allows more product facings than the standard D5X or D5NX. The narrower footprint reduces required floor space. Other merchandising features include full vision glass ends, illuminated canopy signs, improved ledge lighting and greater shelf placement flexibility.

REMOTE	L	D	H
D6NX-4LEP	51 3/8"	37"	87"
D6NX-6LEP	75 3/8"	37"	87"
D6NX-8LEP	99 3/8"	37"	87"
D6NX-10LEP	147 1/2"	37"	87"



Extra tall unit allowing for more product facings than the D5X-ULEP!

HUSSMANN® *Excel*

DSX-LRE



SELF-SERVICE, REMOTE UNIT SHOWN

The DSX-LRE is designed for easy rear loading from a cooler adjacent to the back of the case. Product is stocked quickly and stays cold. This is a benefit in heavy traffic stores with rapid product turnover.

Doors are constructed in three panels, with one three panel door opening every four feet. The three panels can be slid together to the right or the left, so you have complete rear access to the full merchandising area in front of each door opening.

REMOTE	L	D	H
DSX-RLRE	99 3/8"	45 1/2"	81 7/8"
DSX-LALRE	142 1/2"	45 1/2"	81 7/8"

Designed for easy rear loading from a cooler adjacent to the back of the case!

SPECIAL FEATURES



REAR SLIDING DOORS FOR EASY STOCKING

HUSSMANN® Excel

D5XRRI

The D5XRRI provides the unique benefit of being stocked from the rear using roll-in milk racks. The case is attached to a walk-in cooler, so the milk doesn't leave its refrigerated environment during stocking. Curtains are used behind the milk to reduce air currents and shield the walk-in storage from view.

REMOTE	L	D	H
D5XRRI-6	75 3/8"	51 3/4"	85 3/4"
D5XRRI-8	99 3/8"	51 3/4"	85 3/4"
D5XRRI-12	147 1/2"	51 3/4"	85 3/4"



Convenient Stocking!
Stocked from the rear using roll-in milk racks!

SPECIAL FEATURES



REAR OF UNIT WITH CURTAINS



UNIT SHOWN WITH ROLL-IN RACKS

HUSSMANN® Excel

D6X-ULEP

Like the D5X-ULEP, the D6X-ULEP is an ultra low front dairy case that helps you create a total "Wall of Product" in your dairy/deli departments. Front is lowered to be even with bottom display racks so that customers have full view of all product facings, top to bottom.

REMOTE	L	D	H
D6X-40ULEP	51 3/8"	42"	89 1/4"
D6X-60ULEP	75 3/8"	42"	89 1/4"
D6X-80ULEP	99 3/8"	42"	89 1/4"
D6X-120ULEP	147 1/2"	42"	89 1/4"



P4X-E

The P4X-E creates a dramatic, highly flexible display with a wide assortment of product types. Superior display features include full vision glass ends, illuminated canopy signs, improved ledge lighting, greater shelf placement and flexibility.

REMOTE	L	D	H
P4X-4E	51 3/8"	42"	81 3/4"
P4X-6E	75 3/8"	42"	81 3/4"
P4X-8E	99 3/8"	42"	81 3/4"
P4X-12E	147 1/2"	42"	81 3/4"

150. Features full vision glass ends, illuminated canopy signs, improved ledge lighting, greater shelf placement flexibility and more!

HUSSMANN® SPECIALTY

FMSS

The FMSS, refrigerated, cross merchandising self-service case, allows opportunities to add sales of complimentary products in any department. It can be used in front of any service case or custom fixture. In addition, base heights can be adjusted to fit various applications.

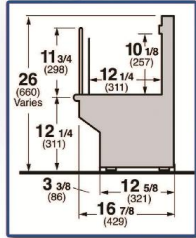

REMOTE	L	D	H
FMSS-3	51 3/8"	16"	28"
FMSS-4	75 3/8"	16"	28"
FMSS-6	99 3/8"	16"	28"
FMSS-7	147 1/2"	16"	28"

Use in Various Departments or Applications!



**Increases
Merchandising Sales!**

HUSSMANN® SPECIALTY

RM

The large single deck display on the R11 creates an excellent, easy access merchandising platform with every product in full view. The curved glass on sides and ends creates an attractive, smooth contour around the island. The R11 places every item at center stage ... within easy reach and with unobstructed visibility. Use the R11 to place high margin items on a display that really attracts attention. To accent your creative product display, the R11 comes with a non-refrigerated top area that can be used for products and décor items that complement your in-case merchandising.



REMOTE	L	D	H
R11-8	96"	72"	44.38"
R11-10	120"	72"	44.38"
R11-12	144"	72"	44.38"
R11-14	168"	72"	44.38"
R11-16	192"	72"	44.38"

Single Deck, Easy Access Display!

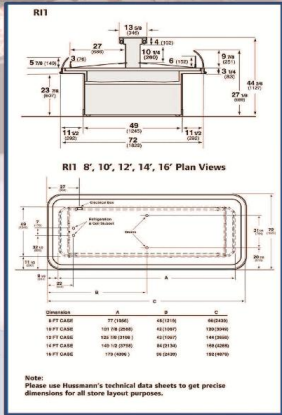

HUSSMANN® SPECIALTY

R12



The R12 creates an attention grabbing display for deli products, prepared foods, sandwiches or other medium temperature products. The low profile design places your merchandise within easy reach, while maintaining visibility throughout the footprint. To accent your case merchandising, the R12 includes a non-refrigerated top display area. This can be used for complementary non-refrigerated items and to add color and visual interest to your footprint.

R12N 8', 10', 12', 14', 16' Plan Views

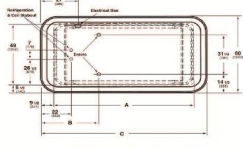

R12 8', 10', 12', 14', 16' Plan Views

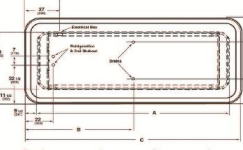

Dimensions	A	B	C
8 FT CASE	77 (2095)	46 (1216)	46 (2049)
10 FT CASE	101 (2604)	46 (1216)	132 (3404)
12 FT CASE	125 (3213)	46 (1216)	156 (3984)
14 FT CASE	149 (3822)	46 (1216)	180 (4564)
16 FT CASE	173 (4431)	46 (1216)	180 (4564)

REMOTE	L	D	H
R12-8	98"	72"	55 3/4"
R12-10	120"	72"	55 3/4"
R12-12	144"	72"	55 3/4"
R12-14	168"	72"	55 3/4"
R12-16	192"	72"	55 3/4"

Attractive, Low Profile Island Display!

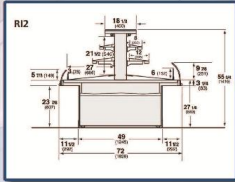

HUSSMANN® SPECIALTY

R13

The R13 brings an elegant exterior design to the island areas of your specialty departments. The curved glass contours and large top display area create an excellent platform for your merchandising artistry ... helping you attract customers by enhancing the visual appeal. This self-service, multi-deck island is perfect for increasing impulse purchases of your specialty/deli products. The R13 merchandising format attracts attention and places products in the middle of your footprint ... where they can't be missed.



REMOTE	L	D	H
R13-10	120"	72"	51 3/4"
R13-12	144"	72"	51 3/4"
R13-14	168"	72"	51 3/4"
R13-16	192"	72"	51 3/4"

Stimulates High Margin Impulse Sales!

IMPORTANT NOTE:

Please use Husmann's technical data sheets to get precise dimensions for all store layout purposes.

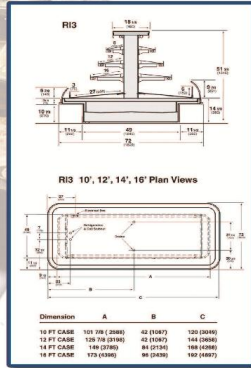

154

CONSULT FACTORY FOR ADDITIONAL INFORMATION

HUSSMANN® SPECIALTY



R14

The R14 creates a look of "dramatic elegance" in your specialty departments. The large capacity merchandising space and extra large top display area create an excellent opportunity for increasing specialty sales with high visibility and excellent product access. This self-service, multi-deck island is a massive attention getter with outstanding visual appeal.... perfect for increasing impulse purchases of your high margin specialty / deli products.

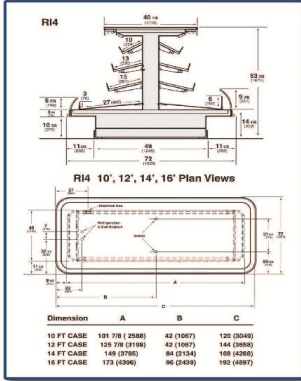

REMOTE	L	D	H
R14-10	120"	72"	52 7/8"
R14-12	144"	72"	52 7/8"
R14-14	168"	72"	52 7/8"
R14-16	192"	72"	52 7/8"

**Extra Large 40" Wide
Non-Refrigerated
Top Display!**

IMPORTANT NOTE:

Please use Hussmann's technical data sheets to get precise dimensions for all store layout purposes.

CONSULT FACTORY FOR ADDITIONAL INFORMATION 155

HUSSMANN® SPECIALTY

CR3D

This 3 zone merchandiser sets the pace for its segment. It allows for self-service, full service, and extra storage all in a small footprint. Having a full range of configurations atop a high-capacity self-service case, the R3 Family redefines what a merchandiser should be.



REMOTE	L	D	H
CR3D-4	50"	55 1/16"	53"
CR3D-5	62"	55 1/16"	53"
CR3D-6	74"	55 1/16"	53"
CR3D-8	98"	55 1/16"	53"
CR3D-10	122"	55 1/16"	53"
CR3D-12	146"	55 1/16"	53"

All Metal Construction!

Durable and reliable service life!



SPECIAL FEATURES



156 Full range of custom configuration options available!

HUSSMANN® SPECIALTY

R3D

This 3 zone merchandiser sets the pace for its segment. It allows for self-service, full service, and extra storage all in a small footprint. Having a full range of configurations atop a high-capacity self service-case, the R3 Family redefines what a merchandiser should be.

REMOTE	L	D	H
R3D-4	50"	50 1/16"	53"
R3D-6	63"	50 1/16"	53"
R3D-8	74"	50 1/16"	53"
R3D-8	88"	50 1/16"	53"
R3D-10	122"	50 1/16"	53"
R3D-12	146"	50 1/16"	53"

All Metal Construction!

SPECIAL FEATURES



Full range of custom configuration options available! 157

HUSSMANN® SPECIALTY

CR3HV-NB (Narrow Base)

The CR3HV-NB, allows for merchandising of the service top, with shelves, pedestals or steps to meet your display objectives. This design also allows for maximum self-service and service product areas to the footprint. Merchandise the self services section, with or without a shelf to increase product facings or pack-out. Unit available with curved or straight glass.



REMOTE	L	D	H
CR3HV-4NB	50 1/4"	50 3/8"	23"
CR3HV-6NB	74 1/4"	50 3/8"	23"
CR3HV-8NB	98 1/4"	50 3/8"	23"
CR3HV-12NB	149 1/4"	50 3/8"	23"

Merchandising Visibility!



SPECIAL FEATURES



R3HV-NB - STRAIGHT GLASS TOP

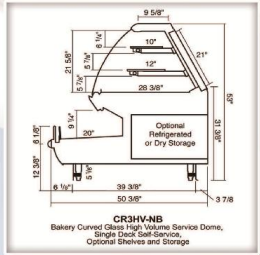

HUSSMANN® SPECIALTY

CR3HV-WB (Wide Base)

Like the CR3HV-NB, the CR3HV-WB, allows for merchandising of the service top with shelves, pedestals or steps to meet your display objectives. Featuring a wider base section, this unit comes with an optional lower shelf, maintaining maximum self-service and service product areas to the footprint.

REMOTE	L	D	H
CR3HV-4WB	50 1/4"	54 3/8"	55"
CR3HV-6WB	74 1/4"	54 3/8"	55"
CR3HV-8WB	98 1/4"	54 3/8"	55"
CR3HV-12WB	146 1/4"	54 3/8"	55"



Merchandising Capacity!

SPECIAL FEATURES

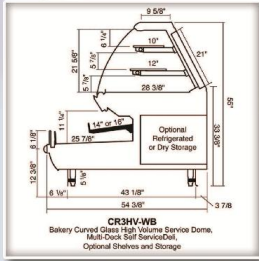

CR3HV-WB
 Bakery Curved Glass High Volume Service Dome,
 Multi Cook Self Service/Deli,
 Optional Shelves and Storage



R3HV-WB - STRAIGHT GLASS TOP

HUSSMANN® SPECIALTY

R3HV-ND (Narrow Deck)



The R3HV-ND allows for merchandising of the service top with shelves, pedestals or steps to meet your display objectives. This unit is a variant of the R3HV Series that features a narrow deck, while maintaining self-service and upper display options to satisfy your merchandising needs. Unit is also available with curved glass.

REMOTE	L	D	H
R3HV-ND	50 1/4"	50 3/8"	53"
R3HV-ND	74 1/4"	50 3/8"	53"
R3HV-ND	98 1/4"	50 3/8"	53"
R3HV-F2ND	146 1/4"	50 3/8"	53"

Allows for full and self-service applications, all in a small footprint!

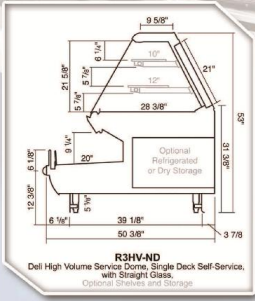

R3HV-ND - STRAIGHT GLASS

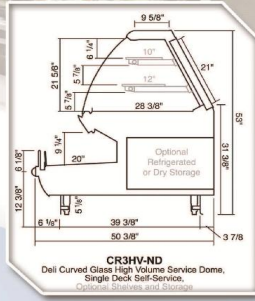

CR3HV-ND - CURVED GLASS

HUSSMANN® SPECIALTY

R3HV-WD (Wide Deck)

The R3HV-WD allows for merchandising of the service top with shelves, pedestals or steps to meet your display objectives. This unit is a variant of the R3HV Series that features a wide deck, while maintaining self-service and upper display options to satisfy your merchandising needs. Unit is also available with curved glass, with an optional shelf for the lower deck.



REMOTE	L	D	H
R3HV-4WD	50 1/4"	54 3/8"	55"
R3HV-6WD	74 1/4"	54 3/8"	55"
R3HV-8WD	98 1/4"	54 3/8"	55"
R3HV-12WD	148 1/4"	54 3/8"	55"

Merchandise the self-service section (wide deck) with or without a shelf to increase product facings or pack-out!

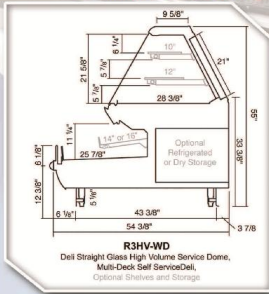

R3HV-WD - STRAIGHT GLASS

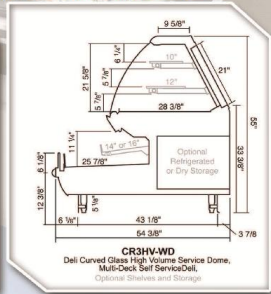

CR3HV-WD - CURVED GLASS

HUSSMANN® SPECIALTY

SHM

The contemporary styling of the SHM places maximum attention on merchandising. A softer, rounder design featuring as standard a white base with black bumper. All SHM merchandisers have the same contour and line up together to create extended product displays.

REMOTE	L	D	H
SHM-SR	36"	39 5/8"	42 7/8"
SHM-4R	48"	39 5/8"	42 7/8"

SELF-CONTAINED	L	D	H
SHM-3	36"	39 5/8"	42 7/8"
SHM-4	48"	39 5/8"	42 7/8"
SHM-4BW	48"	39 5/8"	42 7/8"



Merchandising!

The SHM is a traffic stopper...a product mover... with a display area that creates a dramatic, unlimited view of the product display. Large volume three-step display insert brings the product to the customer and stimulates impulse sales throughout your store.

Can be lined up to create extended product displays!

SPECIAL FEATURES

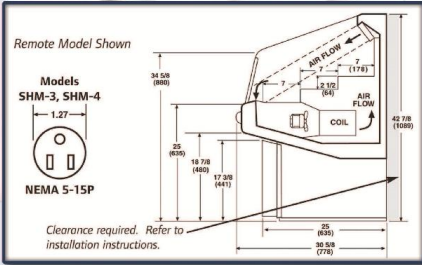

HUSSMANN® SPECIALTY

GSM



The contemporary styling of the GSM places maximum attention on merchandising. The narrow canopy and plexiglass side panels increase product visibility.

All GSM merchandisers have the same contour and line up together to create extended product displays.

72 INCH UNIT

REMOTE	L	D	H
GSM-660	40"	30 5/8"	60"
GSM-672	40"	30 5/8"	72"
GSM-572	52"	30 5/8"	72"

SELF-CONTAINED	L	D	H
GSM-660	40"	30 5/8"	60"
GSM-672	40"	30 5/8"	72"
GSM-572	52"	30 5/8"	72"

Specialty Vertical Merchandisers! SPECIAL FEATURES



60 INCH UNIT

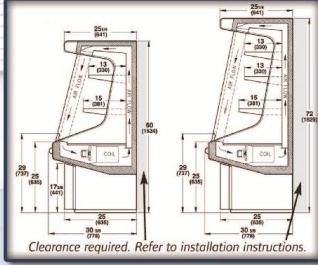

Clearance required. Refer to installation instructions.

HUSSMANN® SPECIALTY



MD

The MD is a medium temperature, self-contained merchandiser featuring a small footprint and full front accessibility to products. The unit is also equipped with four 14-inch shelves which are adjustable to various positions and plexiglass ends, which allow product visibility from the side of the merchandiser.

REMOTE	L	D	H
MD-10	30"	33 5/8"	77"
MD-14	52"	33 5/8"	77"

Specialty multi-deck merchandisers!

SPECIAL FEATURES

High volume self-service merchandiser with front accessibility to products!



BLACK METAL INTERIOR

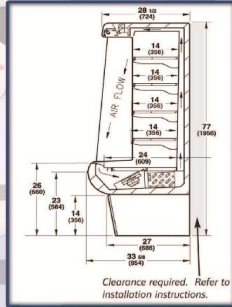

HUSSMANN[®] SPECIALTY

DDSS-4MC



The DDSS-4MC is a high-capacity, multi-deck display merchandiser, featuring a 29" footprint for ideal display of sandwiches, salads, and beverages. Optional features include night curtain, reversing condenser fan motor, locking security cover, view ends and mirrored interior.

REMOTE / SELF-CONTAINED	L	D	H
DDSS-4MC	51"	39 1/2"	74"

UNIT SHOWN WITH OPTIONAL GLASS VIEW ENDS

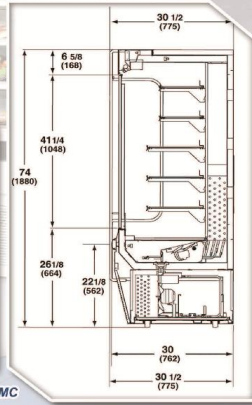

SOLID END PANELS STANDARD WITH DDSS-4MC

CONSULT FACTORY FOR ADDITIONAL INFORMATION 165

PRODUCT CHECK LIST . . .



REGAL

VIENNA

A. REFRIGERATION:

- SELF-CONTAINED
- REMOTE (PLEASE SPECIFY):
 - REFRIGERANT TYPE
 - GRILL OR REMOVABLE PANEL (PANEL CAN BE DECORATIVE OR WITH ANY FINISH)

B. PLUMBING:

- FLOOR DRAIN
- CONDENSATE EVAPORATOR PAN

C. PLACEMENT / VENTILATION:

- 2" OFF OF WALL (INCLUDED)
- 4" CLEAR AREA ABOVE (BOFFITS)

D. LIGHTING:

- FLOURESCENT (STANDARD)
- PROMOLUX
- LED

E. NIGHT SHADES:

- SECONDARY NIGHT SHADE
- ROLL DOWN
- SECURITY NIGHT PANELS

F. MOBILITY:

- CASTERS
- STAINLESS STEEL LEGS / BULLET FEET

G. EXTERIOR FINISHES:

- STANDARD GRADE LAMINATE
- STAINLESS STEEL EXTERIOR (UPCHARGE)
- PREMIUM LAMINATE (UPCHARGE)
- WOOD VENEERS (UPCHARGE)

H. SHELVING:

- STAINLESS STEEL (STANDARD ON MOST UNITS)
- GLASS
- WIRE SHELVING (BLACK, WHITE, CHROME, BRASS)
- BLACK STEP SHAM
- STAINLESS STEEL STEP SHAM

A. REFRIGERATION:

- SELF-CONTAINED
- REMOTE (SPECIFY REFRIGERANT)

B. TYPE OF APPLICATION:

- DROP-IN
- SLIDE-IN
- LEGS
- CASTERS

C. GLASS:

- SINGLE PANE GLASS
- INSULATED GLASS

D. DRAIN REQUIREMENTS:

- FLOOR DRAIN
- CONDENSATE EVAPORATOR PAN

E. DOORS:

- SLIDING / HINGED (OPERATOR SIDE / CUSTOMER SIDE)

F. REAR AIR BREATHING:

- DOORS
- SOLID BACK (REVERSE COIL FOR SERVICE / FRONT BREATHING)

G. NIGHT COVERS:

- ACRYLIC NIGHT PANEL WITH LOCK

H. LIGHTING:

- FLOURESCENT (STANDARD)
- LED



A. CASE SELECTION:

- MULTI-DECK
- LEVELS
- SINGLE DECK
- ISLAND
- OTHER
- MODEL #
- LENGTH
- PRODUCT TO DISPLAY
- SPECIFIC OPTIONS

B. REFRIGERATION:

- SELF-CONTAINED
- REMOTE REFRIGERATED:
 - SUPPLIED BY HUSSMANN
 - SUPPLIED BY OTHERS
 - OTHER

C. LIGHTING:

- LED
- FLOURESCENT

D. MOBILITY:

- CASTERS
- LEGS

E. EXTERIOR FINISHES:

- STAINLESS STEEL (UPCHARGE)
- COLOR LAMINATES (UPCHARGE)

RPI Merchandisers are designed for use in stores where ambient temperatures and humidity do not exceed 75 Degrees Fahrenheit and 55% R.H. Locate away from direct sunlight, rapid air currents and extreme temperature changes. Exposure to air currents from ceiling fans, air conditioning diffusers, ovens, etc. will disrupt the case air curtain and refrigerated zone.

RPI in line with its policy to continually improve its products reserves the right to change materials and specifications without notice.



RPI INDUSTRIES, INC.

220 ROUTE 70 • MEDFORD, NJ 08055 • 609-714-2330 (PHONE) • 609-714-2331 (FAX)
WWW.RPIINDUSTRIES.COM • WWW.HUSSMANN.COM