

Operating Manual

PRODUCT: VIAP

Vienna refrigerated cold pan

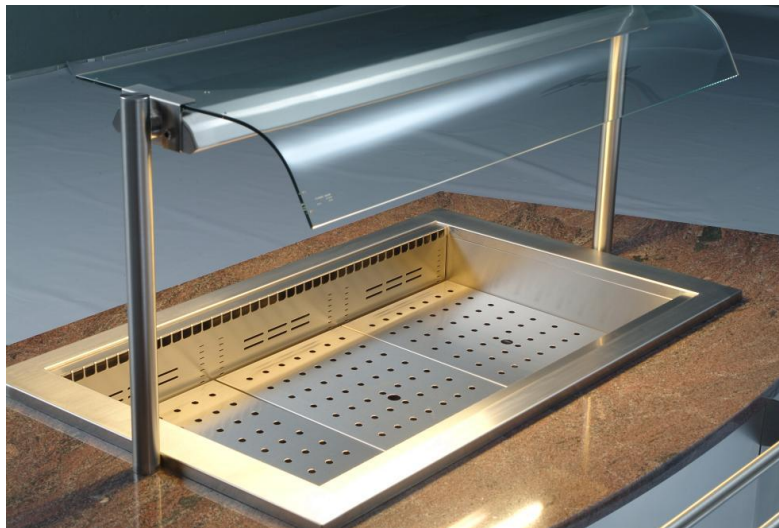

Operating and Maintenance instructions

Information in this manual has to be followed. Please read it carefully before you start to operate your refrigeration well. You can always ensure having a fully functional cooling unit.



Warranty claims can only be forwarded if all instructions are strictly followed!

Operation and maintenance

1	Introduction	2
1.1.	Welcome	2
1.2.	Fundamental Safety Notes	2
1.3.	Warranty and Liabilities	2
1.4.	Symbols and Notes	3
1.5.	Validity	3
2	Purpose of use	4
3	Proper use of the unit	4
4	Improper use of the unit	4
5	Safety notes	4
6	Fundamental operating notes	5
6.1.	Switching on the appliance	5
6.2.	Setting the temperature	5
6.3.	Manual defrosting	5
6.4.	Lighting	5
7	Operating description	6
8	Cleaning and care	7
8.1.	General Recommendations	7
8.2.	Detergents	7
8.3.	Special cleaning hints	8
9	Trouble shooting	9
10	Dangers	10
10.1.	Electrical energy	10
10.2.	Lift-up evaporator	10
11	Maintenance	10
12	Wiring diagram	11
13	Declaration of Conformity	12

OPERATING AND MAINTENANCE

1. Introduction

1.1. Welcome

With the purchase of this new refrigerating equipment you have decided on a product that combines the highest technical demands with practical service comfort. We recommend that you read these operating and maintenance instructions carefully in order to become familiar with the product quickly.

With the proper treatment you will enjoy this appliance for a long time. Please keep these operating and maintenance instructions to consult in case any maintenance and repairs are needed.

We wish you successful business and much pleasure with this appliance.

1.2. Fundamental Safety Notes



The connection and any technical adaptations on the refrigerated well are only to be carried out by specialists!
This is especially valid for any work on the cooling technology, electrical installation, water connection and mechanical work.
Any adaptation is to be authorized by the manufacturer!



- **Those covers bearing a warning may only be opened by specialists!**
- The bottom and back panels are not to be cleaned by water jet.
- Protective covers and devices may not be removed due to risk of injury!
- The control system may only be opened by an expert.
- Air currents near the refrigerating unit resulting from improperly installed ventilation or draughts are to be avoided, in order to ensure the efficient functioning of the refrigerating unit.
- The surrounding temperature may not exceed 25°C; the relative humidity may not exceed 60% over a long period of time.
- Due to risk of injury, sharp objects are not to be stored loosely in the refrigerating unit.
- Any glass parts are to be treated with the necessary care in order to avoid injuries resulting from broken glass.
- Components and operating equipment may only be replaced by original parts.

1.3. Warranty and Liabilities

Fundamentally, our "General terms of sale and delivery" are valid. These are known to the operator upon the signing of the contract at the latest. Claims of warranty and liability for damage to persons and property are not possible, if they result from one or several of the following causes:

- Improper use of the unit.
- Improper assembling, starting up, operating and servicing of the unit.
- Operating the unit with defective safety devices or safety devices which have not been installed properly and are not in working condition.
- Disregard of the references in the operating manual concerning transportation storage, installation, start-up, operation, maintenance and assembling of the unit.
- Unauthorized mechanical or electrical changes to the unit.
- Insufficient maintenance of wear and tear parts.
- Unauthorized repair.
- Force of nature and act of god.

1.4. Symbols and Notes

	<p>This symbol points to important references for the proper use of the unit. <i>Not paying attention to these references can lead to disturbances at the unit or in the environment!</i></p>
	<p>This symbol means a possible or directly threatening danger to the life and health of persons and/or a possibly dangerous situation. <i>Ignoring these references may result in dire consequences for your health and/or can lead to property damages!</i></p>
	<p>This symbol points to operation tips and especially useful information. <i>Helps you to use all functions on your unit optimally.</i></p>

1.5. Validity

These operating instructions are valid for the models:

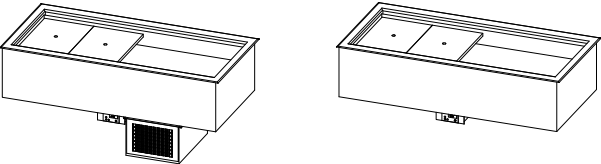
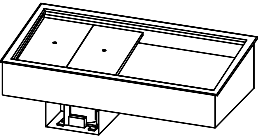
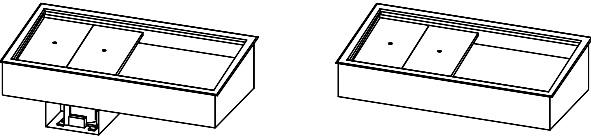
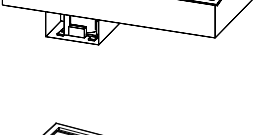
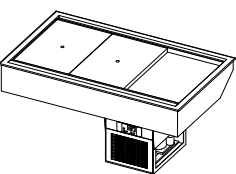
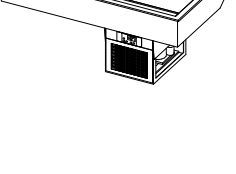
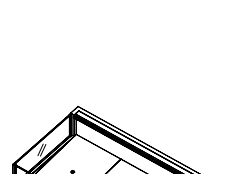
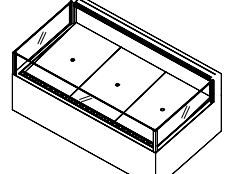
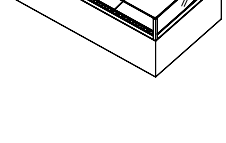
	<p>KOMBI refrigerated wells, ventilated self contained - remote</p>
	<p>UKW GN refrigerated wells, ventilated self contained - remote</p>
	<p>UKW EURO refrigerated wells, ventilated self contained - remote</p>
	<p>UKW-XL refrigerated wells, ventilated self contained - remote</p>
	<p>UKW-sloped refrigerated wells, ventilated self contained - remote</p>
	<p>SNACK refrigerated wells, ventilated self contained - remote</p>
	<p>SNACK XL refrigerated wells, ventilated self contained - remote</p>
	<p>SNACK H refrigerated wells, ventilated self contained - remote</p>
	<p>KOMBI SNACK Baker's counter self contained - remote</p>

2. Purpose of use

The refrigerated wells have been specially developed for mounting in food and dispensing counters. They are suitable for the refrigeration and presentation of foodstuffs and drinks at temperatures ranging from +4°C to +12°C.

These refrigerated wells are not suitable for chilling foods. Any products to be presented have to be chilled to the temperature required before being placed in the unit.

Before the refrigerated wells are filled, please wait until the desired temperature has been reached.



Do not fill with hot foods and do not overfill!

3. Proper use the unit

The drop-in refrigerated wells conform to current state-of-the-art technology, are constructed in accordance with the recognized safety regulations and are reliable.

However, health and/or life threatening circumstances could arise for the user or a third party or damage could be done to the appliance or other property or equipment should the unit be operated by non-trained personnel in a manner that is improper or non-conform.

The appliance may only be operated in a technically acceptable condition and in accordance with all regulations, safety regulations and conscious of risks with regard to the operating instructions! Any other uses beyond those intended are to be considered as not being in compliance with the regulations. The manufacturer/supplier is not liable for any damages resulting from such actions. The user bears the entire risk.

Use in accordance with the regulations includes observance of the mounting and operating instructions and keeping with the inspection and maintenance regulations.

After cleaning the appliance is to be checked for any loose connections, shears and damages. Any defects found should be repaired.

The appliance is not to be used for non-operating purposes.

Any changes to the appliance are to be made solely by the manufacturer!

When replenishing the refrigerant only use the refrigerant indicated on the label. Refilling is only to be carried out by authorized service personnel.

4. Improper use of the unit

The drop-in refrigerated wells are not suitable for chilling foods. No foodstuffs having a higher temperature than indicated are to be filled into the tubs. Safe operation at temperatures of less than +2°C is not possible.

The ventilation slots in the front and back panels of the display area may not be covered as doing so will result in cutting off air circulation and preventing the cooling function.

5. Safety notes

All safety regulations were followed during manufacturing, particularly the VDE regulations (Association for Electrical, Electronic & Information Technologies) and international CEE regulations. The appliance was subject to a comprehensive final check at the plant.

6. Fundamental operating notes

6.1. Switching on the appliance

The refrigerating unit is switched on and off by pressing the STANDBY button (5).

Above the buttons there is a digital display of the cooling regulator. This field shows the medium temperature and any errors.

Before filling the drop-in refrigerated well and display cases with food, please wait until the desired temperature has been reached.



Key 1	UP - button	<i>Defrosting can be started any time by pressing the UP-key for 3 seconds</i>
Key 2	DOWN - button	<i>The DOWN key, among other functions, can acknowledge an alarm</i>
Key 3	LIGHTING	<i>Switch for external lighting (if available)</i>
Key 4	SET - button	<i>While SET key is pressed, the setpoint is indicated</i>
Key 5	STANBY - button	<i>With this key the controller is switched to standby mode. Pressing the key a second time, restarts the unit</i>

6.2. Setting the temperature

The interior temperature is regulated by an electric temperature regulator. This is located underneath the refrigerated well and is easily accessible.

On the service side the refrigerated well is set at a temperature of 6°C. Your desired temperature can be set by holding down the SET button (4) and simultaneously pressing UP - button (1) for higher temperatures or DOWN - button (2) for lower temperatures.

i **The desired value can only be set within a certain range in order to prevent any operating errors.**

After resetting the temperature some time needs to pass before the desired temperature has been achieved. Please check the interior temperature a few hours afterwards with an exact thermometer and reset the thermostat if needed.

Depending on the surrounding temperature and humidity, the interior temperature is not to be set too low as this could lead to icing on exposed areas of the cooling element. This will interfere with the cooling performance and with the continuous defrosting which has been set by your specialized dealer for a certain interval.

6.3. Manual defrosting

Defrosting can be started any time by pressing the UP - button for 3 seconds. During the process of defrosting the respective LED is illuminated. The LED flashes if defrosting is requested, but may not be started yet due to interlock conditions.

6.4. Lighting

External lighting of the refrigerated well can be connected to the cooling regulator and is then switched on and off by pressing button (3).

8. Cleaning and care

Following is some advice on maintenance, care, trouble shooting and service for your cooling cabinet. The interior and the outside of the unit have to be cleaned every day in accordance with hygiene regulations. Only then can you guarantee optimal presentation of the goods.



CAUTION:

Before you start to clean and care switch off the appliance and disconnect it from the mains!

For cleaning purposes the unit should be turned off. Therefore, the best time for cleaning is at the end of your working day.

The refrigerated well can be switched off during the night and outside of opening hours.

8.1. General Recommendations

- The unit has to be cleaned daily.
- Wear acid-proof gloves while cleaning the parts to prevent skin irritations.
- After cleaning with special cleaners you have to wash all parts with clear water and dry them so that there is no cleaner residue on these parts.
- It is absolutely necessary to bear some fundamental things in mind to keep this stainless steel unit working and to maintain its long life:
 - always keep the stainless steel surface clean.
 - make certain there is always enough fresh air on the surface.
 - never let the surface come into contact with rusty material.

8.2. Detergents



Use the following detergents!

- Lukewarm soap water
Use lukewarm soap water for all surfaces that are in direct contact with the goods.
- Glass-cleaner
Removes grease from glass-surfaces. You can lift the glass panels for easy cleaning of the glass and the surfaces underneath.
- Stainless-steel-cleaner
The stainless steel surfaces should be cleaned with a stainless-steel-cleaner only.
- Lamps
The lamps are to be cleaned with soft paper or cloth only.
- Drawers, GN pans
Easily removable without tools for separate cleaning.
Use brushes with plastic or natural bristles for cleaning.



Avoid the following detergents!

- Do not use acid, bleaching or chlorine cleaners.
- Never use high-pressure, water pressure or steam jet cleaning machines.
- Do not use inflammable detergents.
- Never use sharp-edged or metallic tools like Steel-wool or Scrubbing cleanser for cleaning.

8.3. Special cleaning hints

- Remove the inner tub **(1)** (inner well and side panel) from the refrigeration well and tilt the evaporator **(2)**, then sway the lock **(2)** to the left. Now the evaporator is fixed and you can clean the interior. First of all remove crass dirt to avoid a blockage of the drain.

Picture 1



Picture 2



Picture 3



- The evaporator and the interior **(3)** have to be cleaned with lukewarm soap water. Fan in low voltage, which allows for danger-free rinsing of the evaporators and the fan with a hand spray. Always dry the interior after cleaning. After cleaning lift the evaporator, remove the lock and drop the evaporator, drop in the inner tub **(1)**, position the hanging track and drop in the inner well.
- Never clean the rear or the bottom of the tub with a water hose or a scrubber. Avoid flowing water near this areas.
- All other surfaces can be cleaned with soft detergents or water.
- If the condenser is contaminated it has to be cleaned with a broom or a vacuum cleaner.
- Do not close or put any objects in front of the condenser openings for fresh air because otherwise the refrigerating power will be reduced.



CAUTION:
After all cleaning has been completed the refrigeration well has to be returned to its original state in order to guarantee efficient operation!

In addition to daily cleaning, service and maintenance of the cooling cabinet is required to be carried out in regular intervals by qualified specialists.

(see Chapter 11 MAINTENANCE)

9. Trouble shooting

Before requesting service, please check the following:

If the appliance is not working at all please check whether:

- The power supply is interrupted *Self-checking*
- A fuse has blown *Self-checking*
- The plug is firmly in the socket *Self-checking*
- Power has been switched on *Self-checking*
- The electronic has been properly set *Self-checking*

The refrigeration equipment is working, but incorrect:

The products are too warm or too cold:

- Is the condenser clean? *Self-checking*
- Is the surrounding temperature too high? *Self-checking*
- Is there too much food or is it too warm? *Self-checking*
- Has the evaporator not been defrosted? *Self-checking*
- The refrigerated well is subject to strong draughts *Self-checking*
- The cooling unit is malfunctioning **Customer service**
- The cooling regulator is set wrong **Customer service**

The evaporators are constantly iced up:

- Defrosting does not begin **Customer service**
- The ventilators are not running **Customer service**
- The air circulation in the well is blocked *Clear the ventilation openings*

Status display and error notification

Message	Cause	Error elimination
Temperature indication flashes	Refrigerating chamber temperature beyond alarm limits (parameter A1 A2)	
E0 flashes	Refrigerating chamber sensor F1 error, break or short-circuit	Control sensor. Controller operates according to with parameter c3.
E1 flashes	Sensor F2 error, break or short-circuit	Control sensor. At setting [c3=1] the controller operates in timed defrosting modus (defrosting time as set in d3).
EP flashes	Data loss at parameter memory	Unplug the appliance. Press and hold down buttons (4) SET and (1) UP and plug the power plug back into the socket. By doing so the electronic will re-program itself. If Error occurs again please contact customer service.

Should the options listed not be the cause of the error, please contact customer service.

IMPORTANT:



We are not liable for loss of goods, even if the appliance is still covered by warranty.

It is therefore recommended that the temperature of the appliance be checked periodically.

10. Dangers

10.1. Electrical energy

Switch the appliance off immediately upon interruptions in the electrical power supply!

Any work carried out on the electrical units or utilities may only be carried out in accordance with electrical regulations by an electrician specialist or by those being instructed and supervised by an electrician specialist.

Appliances and unit components which are subject to inspection, maintenance and repair work have to be completely disconnected and volt-free. First, check as to whether the activated parts have indeed been disconnected and are volt-free, then ground and short them out. Insulate any adjacent parts that are also energized!

10.2. Lift evaporator

Many cooling appliances are equipped with gas springs, which keep the evaporator in the upright position during cleaning and service. Once the gas springs begin to weaken and are not able to keep the evaporator in the upright position anymore, they are to be removed and replaced immediately by a specialized service representative.

11. Maintenance

In order to guarantee efficient operation of the refrigerated well along with optimum presentation of the goods, the entire technological equipment has to be checked and maintained regularly.

The following should be done:

- complete cleaning of the entire refrigerated well
- checking the ventilator for functionality
- checking the thermostat setting
- checking the temperature of the drop-in refrigerated well
- checking and cleaning the drainage lines and drip water evaporation
- checking the gas spring on the evaporator
- cleaning the condensers on the cooling unit
- checking the amount of refrigerant
- making a security check of the unit

12. Wiring diagram

Wiring diagram: UKW, UKWS, UKW XL, EURO, KOMBI, SNACK - self contained

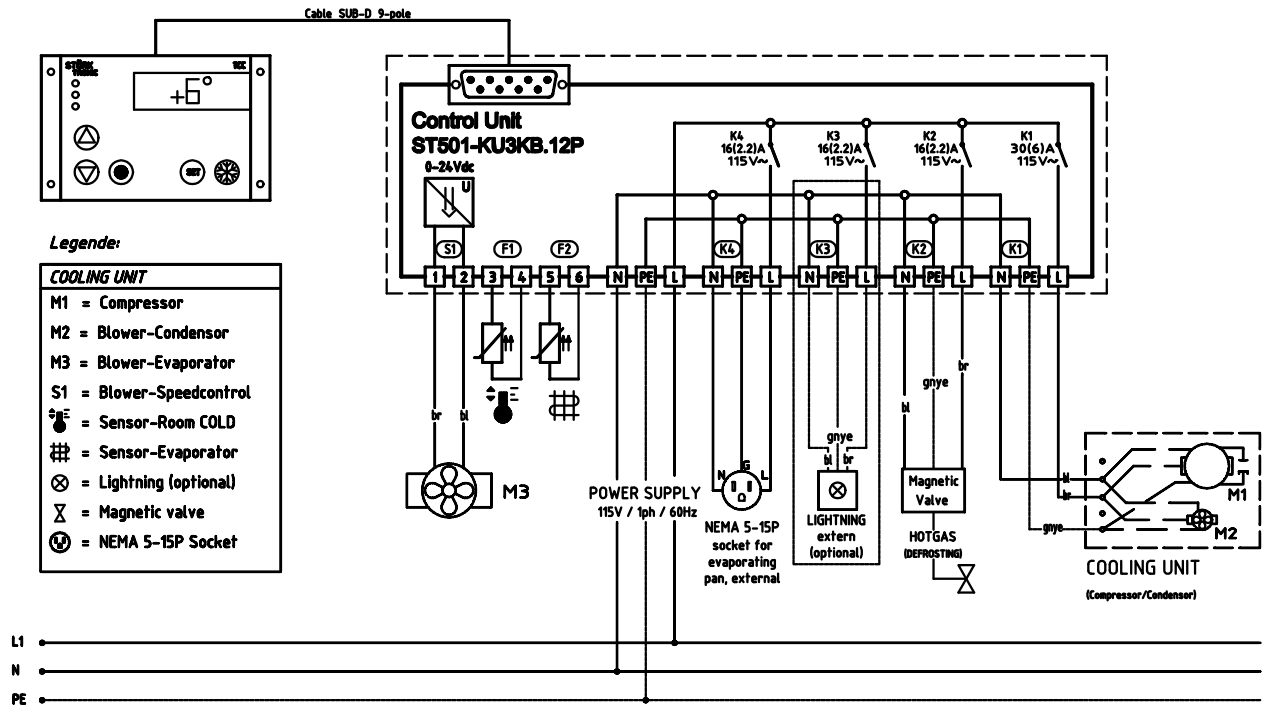

Wiring diagram: UKW, UKWS, UKW XL, EURO, KOMBI, SNACK - remote

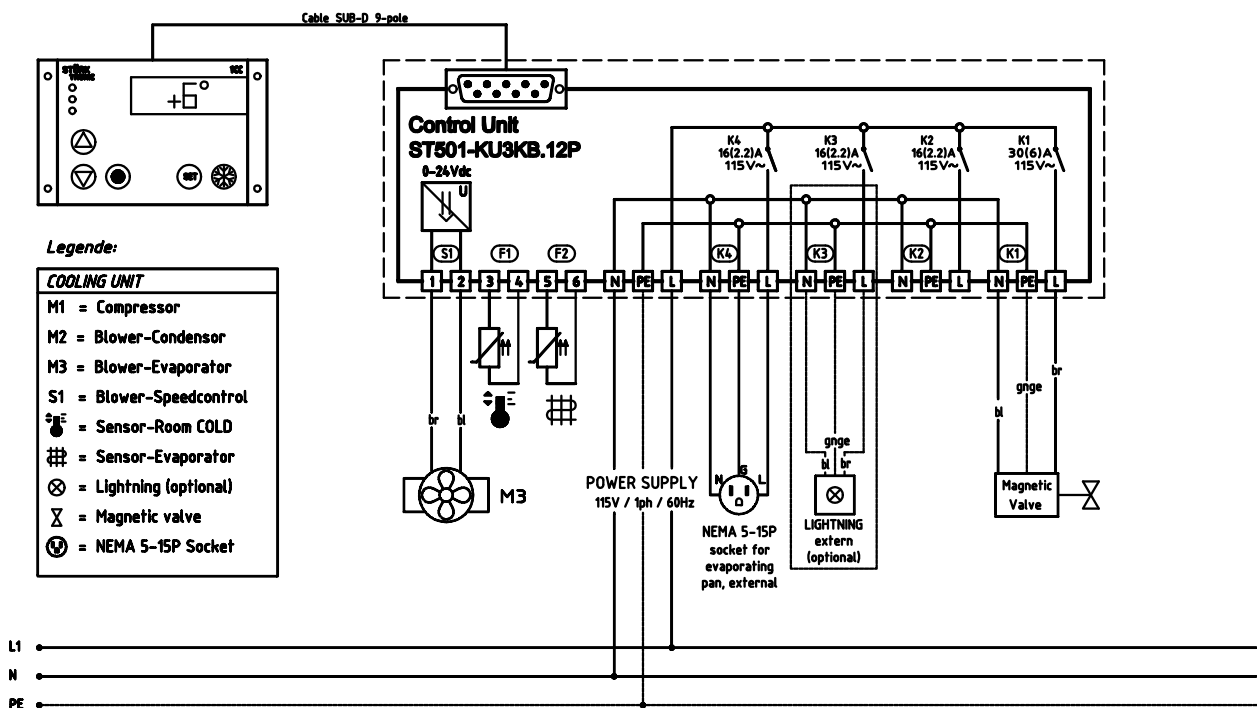



DECLARATION of CONFORMITY

Confirming the EC directives 73/23/EEC and 89/336/EEC

Company

Ausseer Kälte und Edelstahltechnik GmbH

A-8984 Kainisch, Pichl 66

We herewith declare under our sole responsibility that the AKE product
REFRIGERATED WELL - ventilated

types designated as: **UKW...**
UKWS...
Euro...
Kombi...
Snack...

which is covered by this declaration, meets all safety provision of the EC directives **73/23/EEC** amended by 93/68/EEC (Low-voltage directive) and **89/336/EEC** amended by 92/31/ECC (Electromagnetic compatibility EMC directive). These directives represent legal binding laws of the European Union for electrical equipments.

To meet all safety and sanitation EC directives we fully comply with all applicable requirements of the following international and national standards:

HD 277 S1
DIN VDE 32733, issue. 01.89
Druckbeh. V/05.89
HD 280 S1
DIN VDE 0530
EN 60335-1
EN 60730-2
EN 50081-1: EN 55022
EN 50082-1: IEC 1000-4-2-LEVEL IV,
IEC 1000-4-3-5 V/m, IEC 1000-4-4-LEVEL IV
DIN IEC 255 part 1-00
DIN VDE 0435 part 201/05.83
DIN IEC 255 part 0-20
DIN VDE 0630/04.86

Andreas Pilz
Managing director